

QST

september, 1940

25 cents

30c in Canada

devoted entirely to

amateur radio

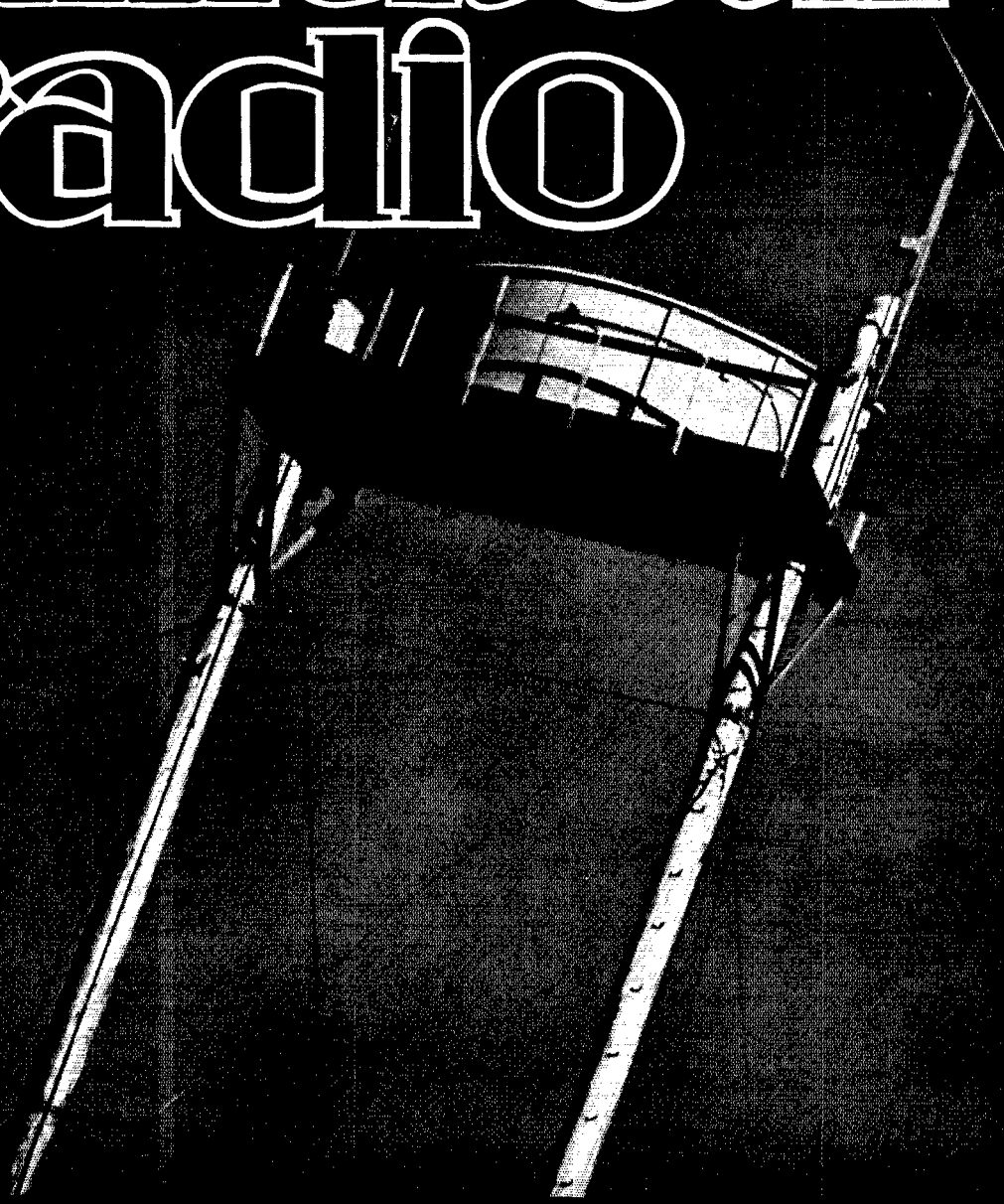

In This Issue—An Effective Low-Frequency Converter

Collins 21 A • Aircooled 5 kw Broadcast

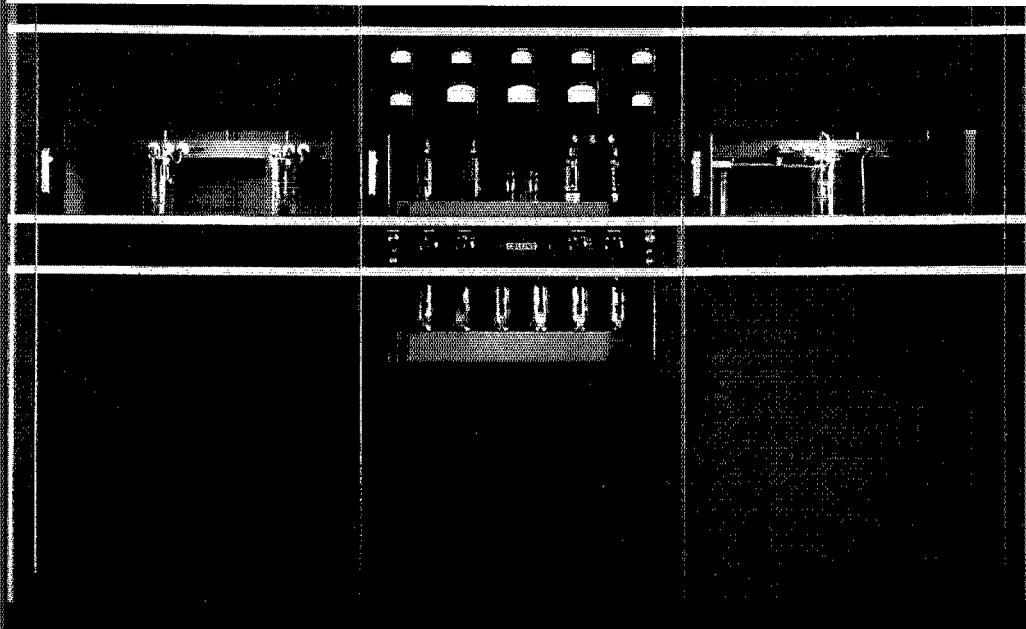

Quality . . . unequaled
Beauty . . . unparalleled
Price unrivaled

COLLINS RADIO COMPANY

CEDAR RAPIDS, IOWA

NEW YORK, N. Y.

New DIRECTION FINDER

Model S-30 Radio Compass and Direction Finder covers from 200 to 3000 kc (1500 to 100 meters) on 3 bands—Beacon, Broadcast and Marine. Has provision for external speaker. Welded aluminum cabinet houses the receiver and supports the rotatable 12-inch loop antenna. Power supply in separate cabinet. Operates from 6 volts. \$99.50 NET

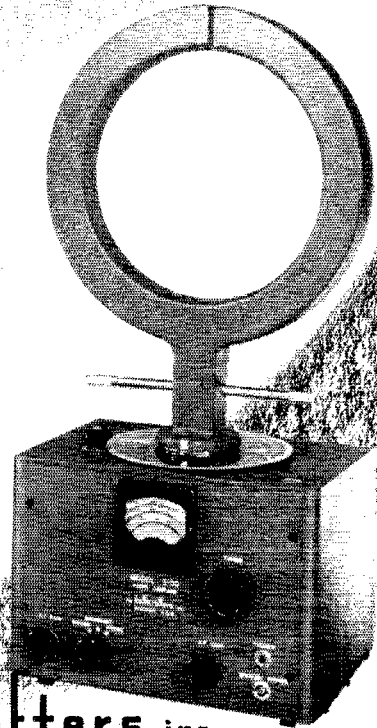

the **hallicrafters** inc.
CHICAGO, U. S. A.

USED BY 33 GOVERNMENTS • SOLD IN 89 COUNTRIES

New PORTABLE COMMUNICATIONS RECEIVER

Model S-29 Sky Traveler operates on 110 volt AC or DC or from self-contained batteries. Covers from 542 kc to 30.5 mc (553 to 9.85 meters) on 4 bands. Built-in collapsible antenna extends to 3 feet. *Battery life prolonged through self-contained charging circuit.* Automatic noise limiter, electrical bandspread, built-in speaker, etc. \$59.50 NET

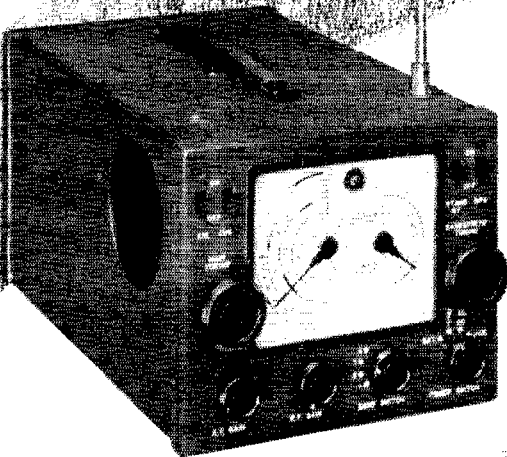

I was designed to Government Specifications --and you know what that means! For top performance on all bands, tell Bob you want a Hallicrafters Super Skyrider (Model SX-28)

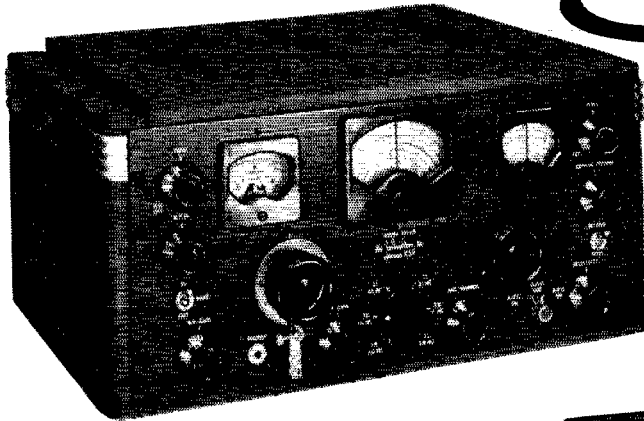

I am just about the "hottest" thing out. A real communications portable. I receive 9-500 meters on self-contained batteries or AC-DC. I have an automatic noise limiter, electrical band spread, built-in speaker, collapsible antenna that extends 3 feet, 9 tubes, an automatic charging circuit for the batteries, etc. Send Bob \$5 and tell him you want a Hallicrafters S-29. Shipped on his free trial plan!

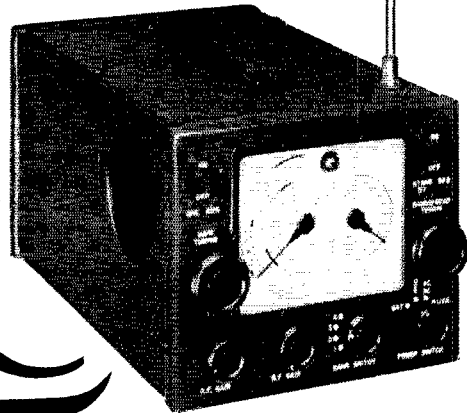

I sell all makes and models of receivers, xmtrs, parts. I want to help you get the best apparatus for your use and to see that you are 100% satisfied. I guarantee you can't buy for less or on better terms elsewhere. Write and tell me what you want and how you want everything handled. Bob Henry W0ARA

HENRY RADIO SHOP
BUTLER, MISSOURI

SEPTEMBER 1940

VOLUME XXIV

NUMBER 9



STAFF

Editorial

KENNETH B. WARNER, W1EH
Editor and Business Manager

CLARK C. RODIMON, W1EZ
Managing Editor

GEORGE GRAMMER, W1DF
Technical Editor

DONALD H. MIX, W1TS
BYRON GOODMAN, W1JPE
Assistant Technical Editors

EDW. P. TILTON, W1HDQ
Contributing Editor, U.H.F.

VERNON CHAMBERS, W1JQ
Technical Information Service

JAMES J. LAMB, W1AL
Research Engineer, A.R.R.L.

Advertising

F. CHEYNEY BEEKLEY, W1GS
Advertising Manager

CHARLES BRUNELLE
Asst. Advertising Manager

Circulation

DAVID H. HOUGHTON
Circulation Manager

RALPH T. BEAUDIN, W1BAW
Asst. Circulation Manager



OFFICES

38 La Salle Road
West Hartford, Connecticut

Subscription rate in United States and Possessions, \$2.50 per year, postpaid; all other countries, \$3.00 per year, postpaid. Single copies, 25 cents. Foreign remittances should be by international postal or express money order or bank draft negotiable in the U. S. and for an equivalent amount in U. S. funds.

Entered as second-class matter May 29, 1919, at the post office at Hartford, Connecticut, under the Act of March 3, 1879. Acceptance for mailing at special rate of postage provided for in section 1103, Act of October 3, 1917, authorized September 9, 1922. Additional entry at Concord, N. H., authorized February 21, 1929, under the Act of February 28, 1925. Additional second-class entries to cover sectional editions authorized March 20, 1935.

Copyright 1940 by the American Radio Relay League, Inc. Title registered at United States Patent Office.

QST

devoted entirely to

AMATEUR RADIO

PUBLISHED MONTHLY, AS ITS OFFICIAL ORGAN, BY THE AMERICAN RADIO RELAY LEAGUE, INC., AT WEST HARTFORD, CONN., U. S. A.; OFFICIAL ORGAN OF THE INTERNATIONAL AMATEUR RADIO UNION



CONTENTS

Editorials	7
QST Visits Riverhead and Rocky Point	8
A Low-Frequency Converter <i>Raymond W. Woodward, W1EAO</i>	15
Our Cover	18
F. M. Limiter Performance <i>G. H. Browning</i>	19
What the League Is Doing	22
The T-Matched Antenna <i>John D. Kraus, W8JK and Stocker S. Sturgeon, W8MPH</i>	24
Predictions of Useful Distances for Amateur Communication <i>N. Smith and S. S. Kirby</i>	26
Code Proficiency Runs from W1AW	27
Central Division Convention	27
K7BUB — Ham Paradise in Alaska	28
New Hampshire State Convention	29
Silent Keys	29
Naval Communications Reserve Notes <i>Lt. Cmdr. John L. Reinartz</i>	29
Automatic Tuning for the Amateur Transmitter <i>W. M. Atkins, W9TJ and C. T. Read, W9AA</i>	30
Results, Fourth U.H.F. Contest and Relay <i>J. A. Moskey, W1JMY</i>	32
The Survey of Headquarters	33
On the Ultra Highs <i>E. P. Tilton, W1HDQ</i>	34
U.H.F. Contest and Relay	37
WWV Schedules	44
A.R.R.L. QSL Bureau	44
Got Your Code Proficiency Certificate?	38
Oklahoma State Convention	38
Correspondence	39
The 1.75-Mc. W.A.S. Party <i>E. L. Battey, W1UE</i>	40
Hints and Kinks <i>Temperature Compensation to Reduce Receiver Drift — Replacing an 83 with 866 Jr.'s for Higher Voltages — Keying-Monitor System — Sure-Fire Audio Oscillator</i>	42
Operating News	45
W1AW Operating Schedule	47
Brass Pounders' League	47
How's DX?	48
DX Century Club	52
Hamfest Schedule	56
Catalogs and Pamphlets	66
Wisconsin State Convention	66
New Transmitting Tube — 825	78
Hamads	91
QST's Index of Advertisers	94

Section Communications Managers of the A.R.R.L. Communications Department

All appointments in the League's field organization are made by the proper S.C.M., elected by members in each Section listed. Mail your S.C.M. (on the 16th of each month) a postal covering your radio activities for the previous 30 days. Tell him your DX, plans for experimenting, results in phone and traffic. He is interested, whether you are an A.R.R.L. member or get your QST at the newsstands; he wants a report from every active ham. If interested and qualified for O.R.S., O.P.S. or other appointments he can tell you about them, too.

ATLANTIC DIVISION				
Eastern Pennsylvania Maryland-Delaware-District of Columbia Southern New Jersey Western New York Western Pennsylvania	W3BES W3CIZ W3CCO W8FLA W8FOF	Jerry Mathis Hermann E. Hobbs Lester H. Allen Fred Chichester Kendall Speer, Jr.	6042 Master St. 9701 Monroe St. 3107 Spring P.O. 704 Quinton Ave.	Philadelphia Linden, Maryland Trenton Snyea Lower
CENTRAL DIVISION				
Illinois * Indiana Kentucky Michigan Ohio Wisconsin	W9ILH W9AH W9GRY W8DPE W8AQ W9IIT	Mrs. Carrie Jones Harry B. Miller Darrell A. Downard Harold C. Bird E. H. Gibbs Aldrich C. Krones	2407 Central Ave. 729 E. Lowell Ave. 116 N. Longworth Ave. R.F.D. 2 405 Broad St. 2702 So. 46th St.	Alton Mishawaka Louisville Pontiac Wadsworth Milwaukee
DAKOTA DIVISION				
North Dakota South Dakota Northern Minnesota Southern Minnesota	W9VWL W9ADJ W9IGZ W9VWQ	Anton C. Theodos E. C. Mohler Edwin L. Wicklund Millard L. Bender	Box 444 Box 149 R.F.D. 3 608 N. Huron Ave.	Williston Rapid City Kensington Spring Valley
DELTA DIVISION				
Arkansas Louisiana Mississippi Tennessee	W5ABI W5DWW W5EWD W4DWS	H. E. Vete W. J. Wilkinson, Jr. Jewell W. Cole William Harold Walker	3415 West 12th St. 1523 Laurel St. c/o City of McComb Water Dept. 1901 Cedar Lane	Little Rock Shreveport McComb City Nashville
HUDSON DIVISION				
Eastern New York N. Y. C. & Long Island Northern New Jersey	W2LU W2AZV W2GVZ	Robert E. Haight E. L. Baunach Joseph P. Jessup	511 South Holmes St. 102 Central Ave. 131 California St.	Scotia Massapequa, L. I. Ridgewood
MIDWEST DIVISION				
Iowa Kansas Missouri Nebraska	W9PTR W9IRG W9OUD W9DI	L. B. Vennard Melvin D. Kirby Miss Letha Allendorf William J. Bamer	P. O. Box 304 1015 W. 3rd St.	West Burlington Arlington Joplin Tobias
NEW ENGLAND DIVISION				
Connecticut Maine Eastern Massachusetts Western Massachusetts New Hampshire Rhode Island Vermont	W1CTI W1LIE W1ALP W1IAH W1BFT W1HRC W1KJG	Frederick Ellis, Jr. H. W. Castner Frank L. Baker, Jr. William J. Barrett Carl B. Evans Clayton C. Gordon Clifton G. Parker	19 Merrill Rd. 147 Church 21 Colby Road 239 Columbia St. 163 South Main St. 70 Columbia Ave., Gaspee Box 537	Norwalk Damariscotta North Quincy Concord Plateau, Warwick Morrisville
NORTHWESTERN DIVISION				
Alaska Idaho Montana Oregon Washington	K7GNN W7EMT W7CFY W7GNT W7FCG	James G. Sherry Carl Eichelberger Rex Roberts Carl Austin W. Beale	Route 2 Box 1088 1137 Federal R. 4, School Ave.	Chichagot Kuna Glendive Bend Walla Walla
PACIFIC DIVISION				
Hawaii Nevada Santa Clara Valley East Bay San Francisco Sacramento Valley Philippines San Joaquin Valley	K6ETF W6BIC W6FBW W6TI W6CIS W6MDI KA1GR W6KUT	Francis T. Blatt Edward W. Heim Elbert Amarantes Horace R. Greer Kenneth J. Hughes Vincent N. Feldhausen George L. Rickard Edwin A. Andress	837 16th Ave. 509 Claremont St. 454 Washington St. 414 Fairmont Ave. 625 36th Ave. 113 South Quincy St. Box 849 2921 North Van Ness Blvd.	Honolulu Reno San Jose Oakland San Francisco McCloud Manila Fresno
ROANOKE DIVISION				
North Carolina South Carolina Virginia West Virginia	W4CYB W4BOE/ANG W3GWQ W8OXO	W. J. Wortman Ted Ferguson Frank S. Anderson, Jr. W. D. Tabler	P. O. Box 566 1213 College St. 4703 New Kent Ave. 238 Watson Ave.	Morganton Columbia Richmond Fairmont
ROCKY MOUNTAIN DIVISION				
Colorado Utah-Wyoming	W9EHC W7CLG	Carl C. Drumeller Ernest E. Parshall	819 East Dale St. Salt Creek Electric Plant	Colorado Springs Midwest, Wyoming
SOUTHEASTERN DIVISION				
Alabama Eastern Florida Western Florida Georgia West Indies (Cuba-Isle-of-Pines- Porto Rico-Virgin Islands)	W4DGS W4PEI W4AXP W4AGI CM2OP	James F. Thompson Carl G. Schaal Oscar Cederstrom Leland W. Smith Mario de la Torre	12 Clanton Ave. Waucoma Apts. Lakeview Hotel Second St. & Bruce Ave. 2010 Pennsylvania Ave. Escobar 110 (Altos)	Montgomery Clermont De Funiak Springs Augusta Habana, Cuba
SOUTHWESTERN DIVISION				
Los Angeles Arizona San Diego	W6MQM W6KMM W6BKZ	Ralph S. Click Marson B. Hull Louis A. Cartwright	1038 Milwaukee Ave. 617 North Fourth Ave. 370 Nautilus	Los Angeles Phoenix La Jolla
WEST GULF DIVISION				
Northern Texas Oklahoma Southern Texas New Mexico	W5DXA W5GFT W5SMN W5ENI	Lee Hughes Russell W. Battern Horace E. Bidy Dr. Hilton W. Gillett	125 N. Main St. Box 200 1746 Schley Ave.	Childress Enid San Antonio Lovington
MARITIME DIVISION				
Maritime	VE1DQ	A. M. Crowell	69 Dublin St.	Halifax, N. S.
ONTARIO DIVISION				
Ontario	VE3SG	F. H. B. Saxon	302 Lee Ave.	Toronto, Ont.
QUEBEC DIVISION				
Quebec	VE2CO	Lindsey G. Morris	Apt. 6, 4510 Girouard Ave., N.D.G.	Montreal, P. Q.
VANALTA DIVISION				
Alberta British Columbia	VE4GE VE5DD	C. S. Jamieson C. O. L. Sawyer	581 W. Riverside Drive 2634 West 31st Ave.	Drumheller, Alta. Vancouver
PRAIRIE DIVISION				
Manitoba Saskatchewan	VE4AAW VE4SY	A. W. Morley Arthur Chesworth	747 McMillan Ave. 1071 4th Ave., N. W.	Winnipeg Moose Jaw

* Officials appointed to act until the membership of the Section choose permanent S.C.M.s by nomination and election.

GL-810's Picked for TOP DEPENDABILITY AT LOW COST in 42- to 50-Mc FM Broadcast Service

GL-810's assure excellent continuity of service, plus low-cost operation in the G-E Type GF-1-B frequency-modulation broadcast transmitter.

Tube outages are "out" in commercial broadcast service; lost time means lost revenue. That is why G-E engineers chose GL-810's as the final amplifiers for the new G-E 250-300-watt frequency-modulation broadcast transmitter. The low cost, high efficiency, and stability at high frequencies weighed heavily in making the decision.

GL-810's are fb for high-power ham service. Easy to drive; easy to neutralize; excellent for a-f or r-f service.

Ask your dealer to let you look 'em over . . . And next time you buy, try G.E. and measure the difference! General Electric Company, Schenectady, N. Y.

FB for HIGH POWER! GL-810 Transmitting Triode

Class B Audio—2 Tubes

Ample output to plate-modulate a 1-kw rig; driving power, 13 watts.

Class C 'Phone—Plate Modulated*

Input, per pair 900 watts
Driving power, per pair 17 watts

Class C Telegraph*

Input, per pair—1000 watts, conservatively operated; driving power, 24 watts.

*Intermittent Commercial and Amateur Service

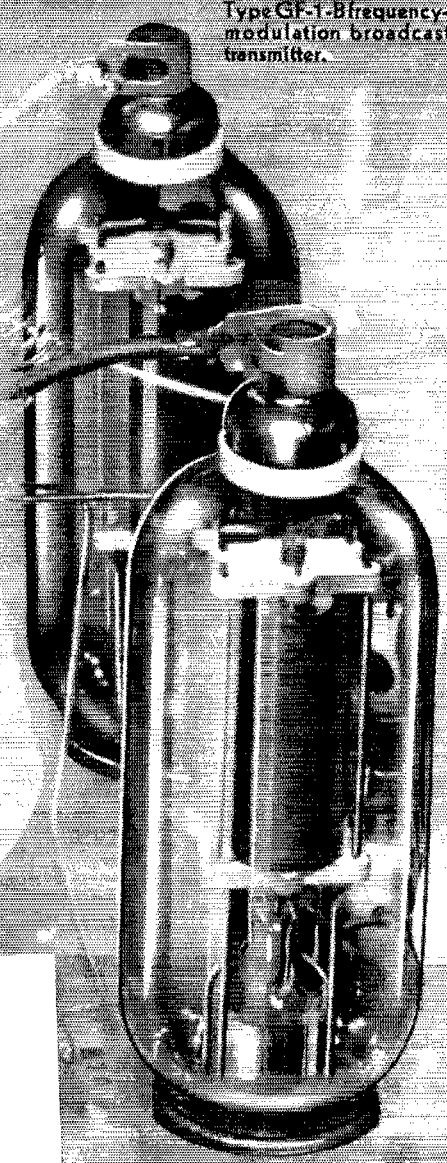

\$13.50

THE AMERICAN RADIO RELAY LEAGUE

Directors

<i>President</i>	
GEORGE W. BAILEY.....	W1KH 74 Webster Road, Weston, Mass.
<i>Vice-President</i>	
CHARLES E. BLALACK.....	W6GG 1273 Main St., El Centro, Calif.
<i>Canadian General Manager</i>	
ALEX REID.....	VE2BE 169 Logan Ave., St. Lambert, P. Q.
<i>Atlantic Division</i>	
WALTER BRADLEY MARTIN.....	W3QV Box 612, Roslyn, Pa.
<i>Central Division</i>	
R. H. G. MATHEWS.....	ex-W8ZN 4534 Dover St., Chicago
<i>Dakota Division</i>	
FRED W. YOUNG.....	W9MZN 107 Hanover St., Mankato, Minn.
<i>Delta Division</i>	
E. RAY ARLEDGE.....	W58I P.O. Box 286, Pine Bluff, Ark.
<i>Hudson Division</i>	
KENNETH T. HILL.....	W2AHC 115 Willow St., Douglaston, L. I., N. Y.
<i>Midwest Division</i>	
FLOYD E. NORWINE, JR.....	W9EFC 7405 Hawatha Ave., Richmond Heights, Mo.
<i>New England Division</i>	
PERCY C. NOBLE.....	W1BVR 37 Broad St., Westfield, Mass.
<i>Northwestern Division</i>	
RALPH J. GIBBONS.....	W7KV c/o United Air Lines, Portland, Ore.
<i>Pacific Division</i>	
J. L. McCARGAR.....	W6EY 66 Hamilton Pl., Oakland, Calif.
<i>Roanoke Division</i>	
H. L. CAVENESS.....	W4DW State College Station, Raleigh, N. C.
<i>Rocky Mountain Division</i>	
GLEN R. GLASSCOCK.....	W9FA 2164 So. Corona St., Denver
<i>Southeastern Division</i>	
WILLIAM C. SHELTON.....	W4ASR Box 652, Daytona Beach, Fla.
<i>Southwestern Division</i>	
<i>West Gulf Division</i>	
WILLIAM A. GREEN.....	W5BKH 801 Ross St., Abilene, Texas

THE AMERICAN RADIO RELAY LEAGUE, INC., is a non-commercial association of radio amateurs, bonded for the promotion of interest in amateur radio communication and experimentation, for the relaying of messages by radio, for the advancement of the radio art and of the public welfare, for the representation of the radio amateur in legislative matters, and for the maintenance of fraternalism and a high standard of conduct.

It is an incorporated association without capital stock, chartered under the laws of Connecticut. Its affairs are governed by a Board of Directors, elected every two years by the general membership. The officers are elected or appointed by the Directors. The League is non-commercial and no one commercially engaged in the manufacture, sale or rental of radio apparatus is eligible to membership on its board.

"Of, by and for the amateur," it numbers within its ranks practically every worth-while amateur in the nation and has a history of glorious achievement as the standard-bearer in amateur affairs.

Inquiries regarding membership are solicited. A bona fide interest in amateur radio is the only essential qualification; ownership of a transmitting station and knowledge of the code are not prerequisite. Correspondence should be addressed to the Secretary.



Past Presidents

HIRAM PERCY MAXIM, 1914-1936
EUGENE C. WOODRUFF, 1936-1940

Officers

<i>President</i>	GEORGE W. BAILEY, W1KH Weston, Mass.
<i>Vice-President</i>	CHARLES E. BLALACK, W6GG El Centro, Calif.
<i>Secretary</i>	KENNETH B. WARNER, W1EH West Hartford, Connecticut
<i>Treasurer</i>	ARTHUR A. HEBERT, W1ES West Hartford, Connecticut
<i>Communications Mgr.</i>	F. EDWARD HANDY, W1BDI West Hartford, Connecticut
<i>General Counsel</i>	PAUL M. SEGAL 1026 Woodward Building, Washington, D. C.

Address all general correspondence to the administrative headquarters at West Hartford, Connecticut.

"IT SEEMS TO US—"

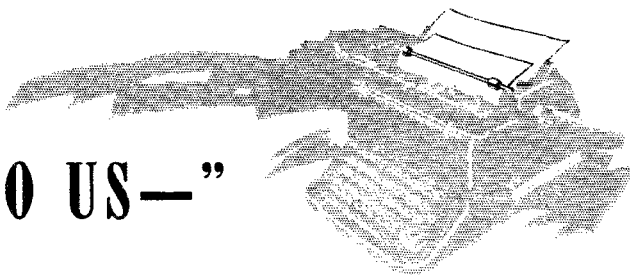

WE ARE puzzled over the apparent lack of amateur interest in frequency-modulated transmission. We've published quite a few articles on the subject, endeavoring to take the initial steps in the now-familiar process of "reduction to amateur practice"—our name for the treatment we amateurs accord each new invention that interests us. We have offered it to you u.h.f. experimenters as containing the answer to many of your problems but you don't seem to have done anything about it. If we should judge by the reports we've actually received, we'd have to say that there are two hams playing with u.h.f. on the East Coast and two in the Northwest and none in between.

Perhaps we're wrong in thinking that most of you fellows are badly bothered by auto-ignition interference on 5 meters, the cure of which is perhaps f.m.'s greatest blessing; maybe you don't need it. Perhaps you're too busy operating for points in the U.H.F. Marathon to have time nowadays for technical developments. Maybe we scared you off by admitting that there is still some difficult work to be done.

At any rate, we still think that u.h.f. men are missing a bet by not taking up f.m. It is our opinion that it does contain the answer to many of our difficulties and that amateur u.h.f. work would be much the richer for its application.

Admittedly there are problems. But don't we thrive on problems? The reward, if we succeed in adapting f.m. to amateur requirements, promises to be fascinating: the disappearance of man-made noise, the consequent extension of operating ranges, the great simplification of transmitters. We still need to know just how f.m. behaves in congested-band operation and how effective a rotary beam is in discriminating in favor of a weaker wanted f.m. signal. We still have to develop a satisfactory and inexpensive f.m. receiver. Matter of fact, the receiver turns out to be quite a problem, regardless of cost, because it is difficult to get sufficient selectivity for amateur-band operation. We've even been wondering whether we won't eventually have to ditch wide-band operation in favor of swings of the

same order of width as in amplitude modulation, primarily to get sufficient selectivity in the receiver. These are all problems for which the answers won't appear until we have enough experienced experimenters to afford a meeting of minds. And we haven't got up that much momentum yet.

The F.C.C. has opened nearly half of the 5-meter band to f.m. work, with no limitation on deviation. You 5-meter men have an enviable record as ingenious experimenters. You have the reputation of not being content simply to operate existing gear. Before you now stretches a new field in which your demonstrated skill is almost certain to yield startling results that will vastly improve your work. Why not give it a whirl?

THIS country is on the eve of so great a need for experienced radio people in industry and in the services that it seems to us unemployment is going to vanish amongst those who have any skill in our art. Everywhere we go in Washington, people speak to us about their needs in radio personnel. As you have read in *QST*, the Navy wants some thousands of operators, signalmen and mechanics, even for the present fleet. The Signal Corps and Air Corps alone are looking for many hundreds, including instructors. Some of the services may have to farm out the training of new personnel to commercial radio schools, so crowded are they, and the schools in turn will have to expand and hire more instructors. The Communications Commission is moving many of its inspectors into its new monitoring establishment so that, in addition to the call for operators reported elsewhere in this issue, F.C.C. is going to have many vacancies amongst its permanent field inspectors to be filled by civil-service examinations. And wherever, in this nationwide expansion, a radio job is filled by promotion, there will be another radio job left vacant underneath. In addition to all this, huge equipment contracts are being let, and the plants of manufacturers are humming.

There is going to be a job in radio for everybody who can handle a soldering iron or copy code.

K. B. W.

QST Visit Riverhead and Rocky Point

Looking Over the Gear at the World's Largest Receiving and Transmitting Stations

Just beyond the town of Riverhead, as you drive out Long Island on Route 51, you'll pass a red and white roadside sign, lonesome-looking in the midst of the scrub pines which somehow thrive in a soil almost wholly sand. It says, simply, "World's Largest Radio Receiving Station." And if you happened to come to Riverhead by way of Route 25, you will already have passed a similar sign in the vicinity of Rocky Point on which the word "Transmitting" is substituted for "Receiving" in an otherwise identical phrase. These signs are modest in size, as roadside billboards go, and can easily be overlooked if your attention happens to be on the road as you pass.

But the ham riding along either road won't need painted signs to tell him that there's something gigantic in the way of a radio station in the vicinity. For here the phrase "forests of poles" begins to take on reality — no other words can do justice to a sight certain to take any ham's breath away. Literally miles of them — short, stubby fellows carrying transmission lines; bigger wooden poles — up to the magnificent 130-footers, the largest ever brought East from the Oregon forests — supporting antennas; steel towers up to 400 feet for still bigger antennas; marching endlessly across the horizon in close formation until from a

distance one has the feeling that here there must have been a forest fire which, stripping the trees of limbs, left the trunks standing. And if you're so fortunate as to be able to visit, as we did, the various transmitting stations, receiving stations, and research laboratories, you'll find that despite all the interesting things to be seen and talked about indoors you can't forget that just outside the building you happen to be in are hundreds and still more hundreds of poles and towers, supporting numberless directive antennas aimed over most of the globe.

Rocky Point and Riverhead are, as most of the amateur world knows, the transmitting and receiving points, respectively, for transocean point-to-point communication. Here are the terminals for circuits operated by RCA Communications to the various countries of Europe, Central and South America, Asia Minor, Africa, and to Canada. In the category of commercial operations also fall such activities as the maintenance of the RCA Frequency Measuring Bureau, a pick-up service for DX reception of foreign broadcasts and directed transmissions to be fed to the broadcast chains, and a relay transmitter service for those who want to send a program from this country across the water. Less well known by amateurs, perhaps, is the fact that here

also are research laboratories for investigating the problems of transmission and reception on all frequencies, from the development of equipment and antennas to the observation and interpretation of propagation phenomena. RCAC's stamping ground includes practically everything that is not broadcasting or manufacturing — everything, in fact, which is of keen interest to the practicing ham. Little wonder that a bunch of hams turned loose in "Radio Central" feel right at home, for here, on a tremendously magnified scale, is the sort of thing we do or hope to do ourselves.

The mixture of the coldly practical commercial and fact-seeking research often leave the visitor with a curious collection of conflicting impressions. He may turn from a laboratory bench where new techniques are being worked out for the ultra-ultra highs and, going into

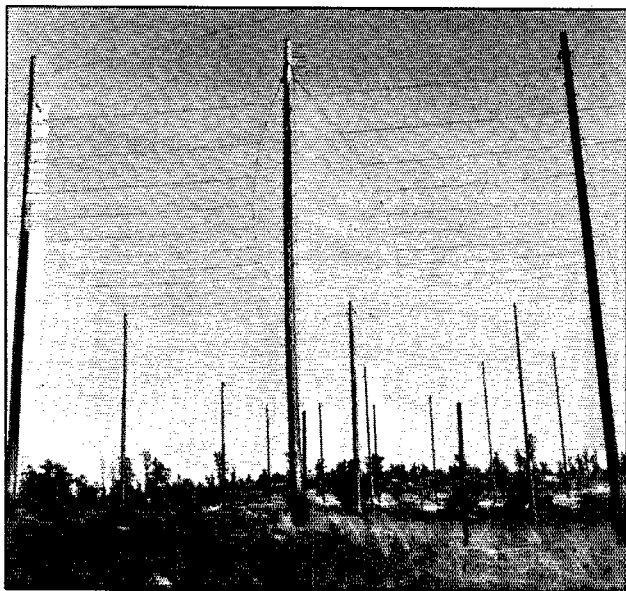

The "Fishbone" type of antenna at Riverhead

another building, find himself confronted by a row of long-wave receivers built more than fifteen years ago — in everyday service, and with many of the original tubes in place! Or he may find a concentric-line controlled high-frequency transmitter standing alongside an Alexanderson alternator—a machine which the present-day generation of amateurs probably never heard of. But both sets are ready to go on the air at an instant's notice. A readjustment of viewpoint is decidedly essential before one can get a real picture. People in the business of communication look on equipment as a means to an end; they do not “rebuild” periodically simply because new gadgets or tubes make their appearance. Final construction is done only after long testing in the laboratory for performance and reliability, and the equipment is good for many years of service. An impossibility for the ham but a “must” for a communications company.

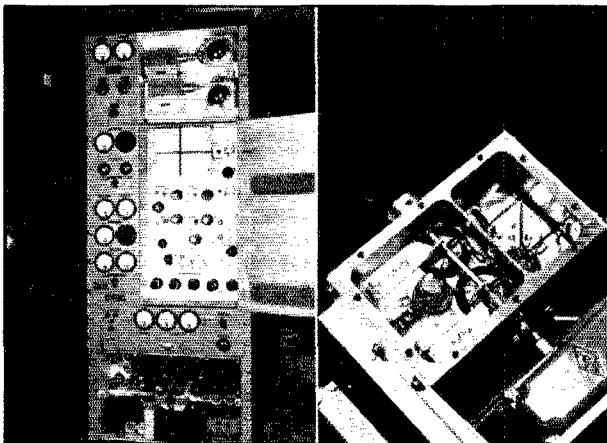

Left—500-Mc. FM receiver for television relay. Right—500-Mc. signal generator, oscillator circuit. Research and Advanced Development, Riverhead.



At Riverhead, May 23, 1940. Left to right — Goodman, QST; Grammer, QST; Peterson, RCAC; Bradlock, RCA Mfg.; Smith, RCA Mfg.; Rodimon, QST.

Visiting the various stations gives one a pretty complete picture of radio communication over the past two decades. “Radio Central” — how many old timers remember that label? — was news for the radio-minded public eighteen years ago. Laid out before short waves, it was planned to install twelve long-wave alternators at Rocky Point, with twelve multiple-tuned antennas, each over a mile long and supported on 400-foot towers, running radially from the station building like the spokes of a wheel. It was estimated that the cost of each of these setups would be a million dollars. The short-wave revolution stopped that program when only two alternators and two antennas had been built. Now the long-wave transmitters

are used only as stand-by sets, to be thrown into service when short waves are out of commission because of magnetic storms or similar disturbances. The present-day communications service, however, is far more extensive than ever was visualized at the start.

The general methods by which point-to-point service is carried out differ considerably from familiar practice, and we believe amateurs will be interested in how this “other part of the family” does its job. The Riverhead receiving site, some 17 miles from the Rocky Point transmitter location, is far enough away and in such a direction that there is virtually no interference from the transmitters. The long-wave receiving installation is still in use, as a few transmitters of this type are in regular operation in parts of Europe. There are sixteen of these receivers, all operating from one pair of antennas; each receiver consists of a series of tuned amplifier stages set to the desired channel. There is no need here for the superhet type of receiver, since the signal frequency is lower than any i.f. in use today. A Beverage antenna is used for pickup; it consists of two parallel wires, nine miles long and separated by six-tenths of a wavelength, or about 5 miles. These waves really are long! The wires are terminated at the far end to prevent reflection, thus making the antenna unidirectional. At the receiving end, one of the wires is equipped with a

If you've ever wondered, as we often have, just what is behind those V-wheels and high-speed messages that are shot out all over the world from far-famed Rocky Point, you'll be interested in the story of our editorial staff's visit to the RCA transmitting and receiving stations on Long Island.



Braaten, W2BSR, and Wickizer, W2DOG, check the power output of a UHF survey transmitter. W2BSR and W2DOG are of the Research and Advanced Development staff, Riverhead.

phasing network so that the currents in the two can be fed in phase to the receiver; this permits some steering of the directive pattern to favor a particular transmitting station. The wires of this antenna, incidentally, are not particularly high; the half of the antenna we saw simply runs along the roadside on telephone poles and the casual observer would never suspect that it is a radio antenna and not a telephone line. We listened a bit on the monitoring circuit to one of the European stations and renewed our long-forgotten acquaintance with long-wave static — and were thankful once more that we don't have *that* to contend with in the amateur bands!

The great bulk of the traffic, of course, is handled on short waves. On the short-wave circuits, diversity reception is used throughout, and the various photographs of the receiving installation will give some idea of its extensiveness. "Space" diversity is used, which means that the signal is picked up on separate antennas separated in space, by distances of the order of a thousand feet, each feeding its own receiver. The rectified outputs of the receivers are combined to form a composite signal in which fading is practically eliminated, since the signals arriving at the three antennas seldom fade in the same direction at the same time. The separation of antennas and num-

ber of antennas and receivers was arrived at after considerable experimental work, and represents a combination which gives optimum results, all factors considered.

Let's consider one setup in more detail. The basic directive antenna is a "fishbone," a high-frequency version of the Beverage wire. It consists of a two-wire transmission line several wavelengths long, running in the direction from which the desired signal comes, and terminated at its far end in its characteristic impedance. At intervals pairs of antenna elements perpendicular to the line are capacity-coupled to it in a symmetrical fashion; the coupling is quite loose, the capacity of the supporting insulator being sufficient. Signals coming from the direction along which the antenna points induce voltages in the antenna elements which add up in phase at the receiving end of the antenna, but the voltages induced by signals coming from other directions are more or less out of phase at the terminals, depending upon the direction of

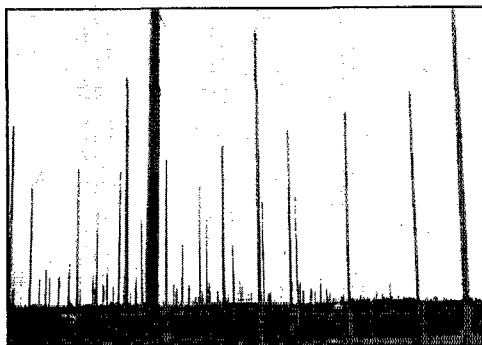

Part of the antenna area at Riverhead. There are over 200 poles visible in this shot!

arrival with respect to the direction of the antenna. The terminating resistor at the far end absorbs the energy picked up from waves coming from the "back" direction, preventing its reflection back along the line to the receiver end and thus making the antenna unidirectional. To increase the directivity two antennas are placed



Left — 500-Mc. inductive output tube and tank circuit. Research and Advanced Development, Rocky Point. Center — Transmission line controlled transmitter at Rocky Point. Concentric circuit contained in large pipe above transmitter. Right — Mr. Hansell, RCAC, explains the operation of the inductive output tube.



Left — R.f. Transmission line distribution rack, main receiving building at Riverhead. Center — Frost, W2LLE (left), and Ashmore, W2IED, pause in their duties as Assistant Engineer in Charge, Riverhead and Senior Frequency Measuring Laboratory Technician, respectively. Right — Section of Control Board, Riverhead.

side by side and operated in parallel. The impedance of the line is about 400 ohms, and the paralleled outputs of the two antennas are fed into a four-wire line having an impedance of 200 ohms, so that no further matching is necessary. The four-wire line is used principally to maintain accurate balance so that stray pickup is minimized — an important consideration when a line may have to run a couple of thousand feet before reaching the station. The transmission lines run through special insulators which act as guides, but to which the wires are not fastened, the insulators being mounted on frameworks set up at about 25-foot intervals. At the distribution rack outside the receiving building shown in one of the photographs the lines are fastened to counterweights which supply all the pull necessary to keep the wires under tension right out to the antenna itself. From the distribution rack, rubber-covered wire lines of the same impedance run through holes in the plate-glass windows into the building.

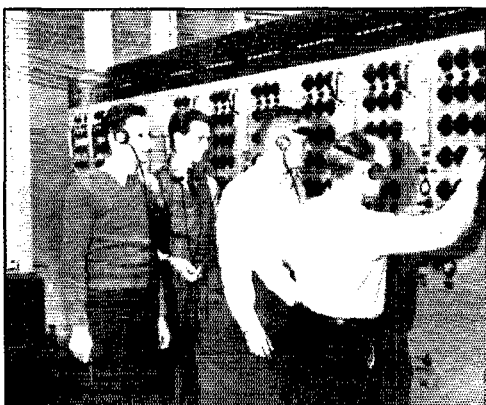

On duty in the main receiving building, Riverhead: Left to right — Lucas, W2LVB; Kulwicz, W2LIM; Spicer, W2LLI; Olsen, W2BHT.

Thus each antenna is really two antennas in parallel, and the complete diversity system uses two more such double antennas, usually spaced at the corners of a triangle, but of course all pointing in the same compass direction. This type of antenna has a rather broad frequency characteristic and will give good results over about a 2-to-1 frequency range, so that several sets of receivers operating on different frequencies can be used simultaneously on one antenna system — provided, naturally, the desired signals are all coming from the same general direction. Antenna groups are provided for all the compass directions from which traffic is received.

In the receiver building, rows and rows of enclosed relay racks hold the diversity receivers. The photograph shows one section of the receiving installation; a complete setup takes three panels such as the group of three on the right-hand end of the near row in the picture. Each diversity outfit has three complete receivers, one on each panel. Each individual receiver is a superhet having three r.f. stages, mixer and oscillator, converting to 300 kc. as a first i.f. This intermediate frequency, in conjunction with the r.f. selectivity, gives satisfactory image suppression. There is no amplification at 300 kc. but the signal is again converted to the second intermediate frequency, 50 kilocycles, where it is amplified in either of two multistage units, one, for telegraph reception, gives a choice of either 1-kc. or 3-kc. bandwidth; the other, for telephone, can be set either for 6.3-kc. or 10-kc. bandwidth. A beat oscillator at 50 kc. is provided for tuning purposes and monitoring. The r.f. end covers the frequency range 3-24 Mc. in three 2-to-1 ranges, for each of which there is a completely separate tuning system selectable by switches. This accounts for the fifteen tuning dials on each r.f. unit, the five circuits (three r.f., mixer and oscillator) being arranged vertically and the three bands horizontally. Ganged tuning is not necessary, since work is with stations operating on spot frequencies, and

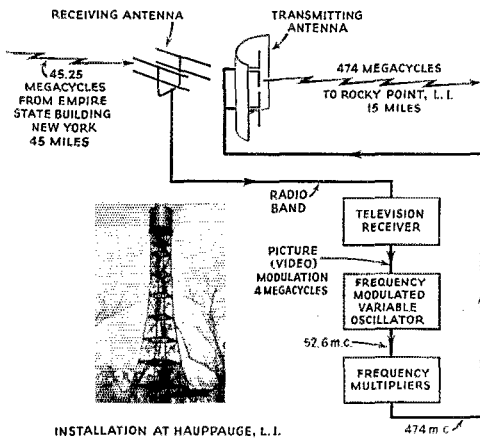

INSTALLATION AT HAUPPAUGE, L. I.

the small amount of time required to reset to a new frequency is of no importance. The final detectors of the three receivers work into a common load resistor and a.v.c. system which biases the three r.f. stages. Thus the receiver getting the strongest input signal takes control of the gain of all three. The 50-kc. component is filtered out of the rectified output and the d.c. is used to key an audio tone, which is the actual signal fed to the recorders. For 'phone reception, of course, ordinary audio amplification is used.

It is something of a shock to listen to the output of one of these receivers. The signal sounds just exactly like what it is — a keyed audio tone. No background noise, no variation in strength, no wobble in frequency, no interference, none of those characteristics we commonly associate with c.w. reception — just a “code practice” type signal. The recording and decoding is not done at Riverhead but at the Broad Street office in New York City, so the tone is sent over a wire line to New York. Some ten different audio tones are used, and each wire line can handle all ten without mutual interference since the tones are separated at the terminal end by a.f. filters. It is possible, however, to hear all ten of them at once by monitoring the line itself; the resultant is for all the world like a popular spot in the 40-meter band on a busy evening! One of the photographs shows a section of the control board where the signals start out over the wire line for New York; a flip of a key switch gives you instantly the station you want. No turning a dial and hunting — just push the button and you have it!

The receivers are operated entirely from batteries floating across the charging circuit. The batteries act as a very heavy filter for the charger, and also provide full power in the event of a line failure. Heavy copper straps carry the current which, at the time we saw the meter, was an even 1140 amperes!

The relay broadcast installation is similar in

principle to the telegraph setup just described. It is, however, entirely separate, with its own building and group of antennas, located in a lonely spot well away from roads where automobile traffic could cause interference. Especially now, transmitters in the various European capitals are monitored continuously. Telephone lines carry the programs to New York, where they can be used as desired.

In visiting Riverhead and Rocky Point you try to see all you can at one place before you go on to the other, so while we might at this juncture go on with the story of the transmitting end of point-to-point communication, it is perhaps better to stick to the one location for a while. There's a lot more to be looked at. For instance, there is the Frequency Measuring Bureau, staffed, by the way, with a large proportion of hams. Duplicate frequency standards in a temperature-controlled room provide a reliable and highly-accurate source of standard signals from 100-kc. crystals. The multivibrators for subdivision of frequency

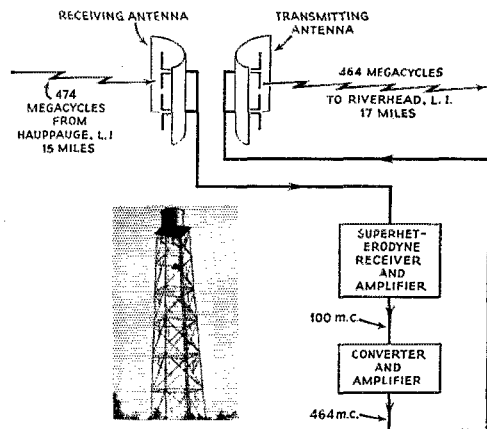

INSTALLATION AT ROCKY POINT, L. I.

and harmonic amplifiers for giving points throughout the spectrum are familiar enough in principle to frequency-conscious amateurs. There is an array of receivers for different frequencies, and again the group of antennas, directive and otherwise, which seems to be associated with every activity. Interpolation between multivibrator harmonics is carried out to a high degree of accuracy by means of micrometer adjustments. All RCA transmitters are regularly checked here, and if the frequency of one gets outside the close tolerances allowed, the manager of that station learns about it in a hurry. The service can be employed by operators of other transmitters as well, including amateurs. Regular checking of broadcast station frequencies accounts for a large part of the time of the Bureau.

Another building is almost filled with recording equipment, where continuous records are kept on

the signal strength of stations on various frequencies and at different distances to obtain wave propagation data. Several f.m. broadcasting stations are recorded, and the same building houses a lot of f.m. receiving equipment, including the latest in the way of audio reproducers. A completely-equipped workshop adjoins the "operating" room — a general rule, by the way, for practically all the laboratories and stations.

The u.h.f. research laboratory is naturally of special interest. Some beautiful equipment here, looking more like a product of the watchmaker's art than like radio apparatus. The 500-megacycle signal-generator oscillator shown in one of the photographs is as pretty a piece of equipment as one could want; the compartment for it is "excavated" from a solid block of brass. The circuit is the Hartley, using a pair of concentric lines with the grid and plate of an acorn triode connected to the outer ends of the inner conductors, tuned by a balanced variable condenser machined out for the purpose. Its dynamic stability is excellent; we listened to the beat note between it and the 500-Mc. harmonic of a crystal oscillator and it was perfectly clean d.c., entirely free from the mushiness which one expects from oscillators operating in the ultra-ultra region.

It is axiomatic that you can't learn much about a thing until you can measure it, so it is not surprising to find a great deal of work going into the building and calibration of measuring equipment for the ultra-highs. The problem of generating r.f. voltages of known magnitude is a particularly important one, hence the care and thought put into such items as the signal generator pictured. But this particular research laboratory is engaged in other work of more obviously practical nature as well; witness the 500-megacycle receiver shown in another photograph. This is part of a project designed to explore the possibility of u.h.f. relaying of television programs with a view to linking cities well beyond normal television-frequency range of each other for chain broadcasting, a project which has now been completed successfully and has demonstrated in a year's

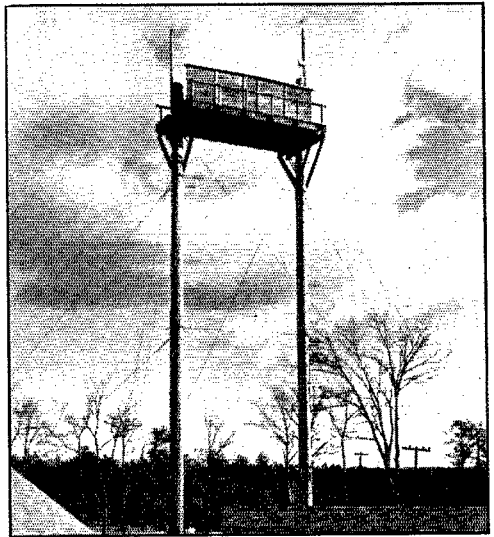

U.H.F. parabolic reflector type antenna, Riverhead (front view).

operation the practicability of continuously-operating, unattended low-power relay stations. The complete system for the tests is shown in the various block diagrams. The Empire State programs were picked up at Hauppauge, L. I., demodulated, and the 4-Mc. band-width video component used to frequency-modulate a 52-Mc. oscillator. The output of the oscillator was tripled twice to 474 Mc. and then fed to an antenna system using a parabolic reflector directed on Rocky Point. At Rocky Point another parabolic-reflector antenna picked up the signal and fed it to a receiver which converted the carrier frequency to 100 megacycles, at which frequency a multi-stage amplifier raised the power level to about one watt at the output terminals. A second frequency conversion changed the carrier to 464 megacycles, and subsequent amplification at the same frequency gave a power output of about five watts to drive the transmitting antenna. Note that at this second relay point the signal is never demodulated; all operations are carried out on the frequency-modulated carrier. This is the type of station which would be used for the intermediate relay or "repeater" points in a long-distance chain. The final station, corresponding to one which would be installed at a television broadcasting station, was set up at the Riverhead laboratory, using the receiver shown in the photograph. Here the 464-Mc. signal was converted to 100 megacycles, amplified, and its frequency changed once more, this time to 29 megacycles, after which it was detected and the video component again amplified. In a broadcast setup the video signal would be used to modulate a regular television transmitter; in this case it was used simply to operate a kinescope for monitoring

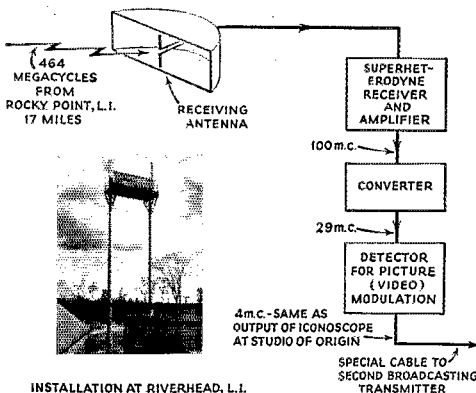

INSTALLATION AT RIVERHEAD, L.I.

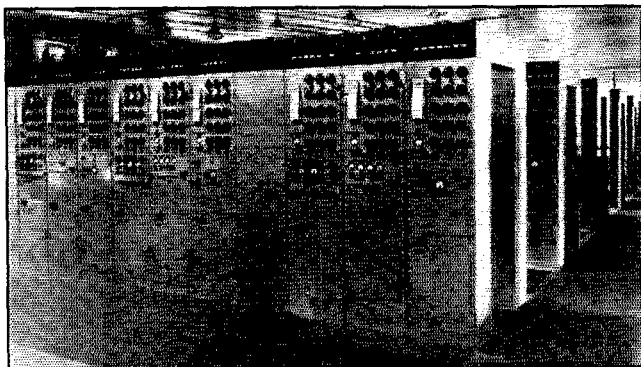

Diversity receivers at Riverhead

purposes. Pictures received over the relay chain at Riverhead were of identical quality to those received at favorable locations in New York directly from Empire State; in general, much better reception was possible at Riverhead than at many points near Empire State because of the absence of the reflections of waves from buildings which often distort the picture even when the receiver is quite close to the transmitter.

An interesting feature of the system is the use of frequency modulation for the relaying. This is principally a matter of convenience, since it obviates the need for critical adjustments of linear amplifiers which would be required with amplitude modulation. The modulation index — 0.4 — is rather low, so that the band-width required is about the same as for amplitude modulation, although this is not a paramount consideration at the carrier frequencies used. It is probable, too, that the new inductive output tubes used in the relay transmitters lend themselves more readily to f.m. than a.m. But speaking of inductive output tubes brings us to Rocky Point, where these tubes are being put through their paces.

Rocky Point — even the laboratory part — has a sort of “power house” atmosphere about it — as indeed it should, considering the number of kilowatts generated by its collection of transmitters on all communication frequencies. The laboratory, a large, high-roofed one-room building (with a few glassed-in offices off in one corner where desk work can be carried out) is a real workshop, where all kinds of high- and low-power transmitters can be — and are — set up on the floor and tested. We saw there experimental u.h.f. oscillators and amplifiers built to test out new power tubes; impressive-looking layouts using large-diameter linear tank circuits, others with spherical-section tanks like that shown in one of the photographs. The latter is used with the inductive output tube, a new form of tube structure which merits introduction to the amateur fraternity, especially since it is now commercially available. Briefly, the tube utilizes a cath-

ode-ray tube type construction, in which a beam of high-velocity electrons is projected along the tube axis to a collector at one end. A control grid is placed near the cathode, and when r.f. is applied to the grid the electron beam is modulated at the frequency of the “excitation.” At an appropriate point between the cathode and collector, the beam passes between the open ends of a linear tank circuit (“linear” used here to indicate a circuit whose resonant frequency is determined by its linear dimensions rather than by coils and condensers, but not necessarily a transmission line of conventional construction).

The modulated beam induces a voltage in the tank which, if the resonant frequency of the tank is the same as that of the r.f. grid voltage, causes a circulating tank current to flow. Thus power is transferred to the output circuit by induction rather than by direct utilization of the electron emission from the cathode, as in ordinary tubes. This type of construction has several advantages for u.h.f. work, among which are minimization of transit-time effects, the use of a rather large tube structure without limiting the frequencies which it is possible to generate, freedom from regeneration, and good efficiency at frequencies of the order of 500 megacycles. Output from the tank circuit is taken by means of a hairpin link inserted in the tank wall, the outer end of such a link being visible on the near side of the unit shown in the photograph. The circuit may be used as an oscillator as well as an amplifier by feeding back some of the tank energy to the grid in the proper phase; this is usually done by running a small transmission line back from

(Continued on page 74)

LICENSED HAMS AT RIVERHEAD

Ashmore, W2IED; Braaten, W2BSR; Carter, W2ADW; Crosby, W2CSY; Etter, W2LXK; Frost, W2LLE; Hannah, W2US; Katzin, W2DTP; Kulwicz, W2LIM; Lucas, W2LVB; MacLean, W2KKM; Martin, W2JRC; Means, W2JER; Mundo, W2BIK; Olsen, W2BHT; Schaeffer, W2BUK; Smith, W2BIU; Spicer, W2LLI; Thomas, W2UK; Tyte, W2BFA; Wickizer, W2DOG; Wilde, W2AVS.

LICENSED HAMS AT ROCKY POINT

Fletcher, W2FFD; Martin, W2MPK; Sheffield, W2ANA; Cain, W2CCC; Lewis, W2JLL.

Gone are the days when every ham's receiver took in "600" as a matter of course — most of the present generation is hardly aware that anything goes on in the once-prized "long-wave" region. But it's an interesting place to do some listening now and then, for newcomer and old timer alike. Code practice and a glimpse of another part of the family for the former; a touch of the good old days brought back to life for the latter. Here's how to get going simply and inexpensively.

◆
 The metal cabinet houses the converter and its power supply. Two frequency ranges cover 90 to 600 kilocycles. The professional-looking calibrated dial is home-assembled from readily-available parts.
 ◆

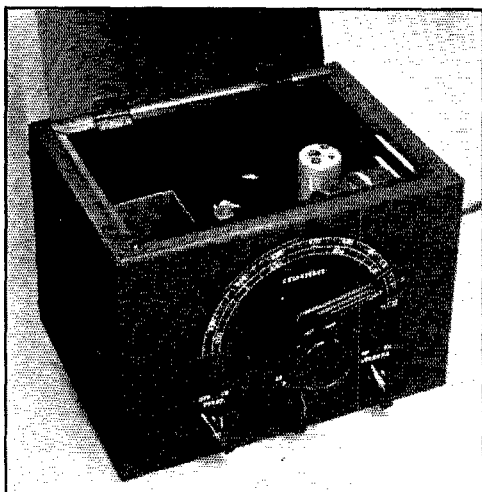

A Low-Frequency Converter

500 to 3300 Meters on Your Communications Receiver

BY RAYMOND W. WOODWARD,* W1EAO

WITH the tendency toward exploration of higher frequencies, and their use in the majority of communication work, many of us have forgotten that there are still "long waves" in regular use. Few amateur shacks have receivers that will go lower in frequency than the broadcast band. But the old timer can still get a kick out of listening to ship-to-shore traffic, and the newcomer can learn a lot about operating procedure if receiving equipment for these long waves is available.

Remember how we used to check the sensitivity of crystal detectors every night at 10 o'clock by NAA's time signals on 2650 meters? Well, NAA is still doing business at the same old stand — only it's called 133 kc. now, and the time signals are given for about 20 out of the 24 hours — much oftener than on the high frequencies.

Then there are the aviation beams from about 200 to 400 kc.; dozens of these can be heard with their continuous "A" or "N" signals and frequent announcements on voice of up-to-the-minute weather. The voice goes on simultaneously with the beam tone signal, but a "Hetrofil"¹ will take the tone out and leave the voice, as many fliers have learned.

Marine radio beacon stations can also be heard if you live near enough to the coast. These oper-

ate from 285-315 kc. mostly, on low power. Their characteristic c.w. signal is sent for one minute by groups of three stations operating in succession on the same frequency.

The writer recently felt the urge to see what was on the "other side of the hill" nowadays, and so constructed a low-frequency converter to go ahead of the regular receiver. The converter covers the range 90 to 600 kc., in two bands. The trusty junk box was drawn upon for most of the components, many of which are defunct broadcast receiver parts. New parts, of course, can be used and these are indicated under the circuit diagram.

The circuit of the converter is entirely conventional, and about the only excuse for describing it is to point out the proper tuned-circuit constants for single-dial tracking in this frequency range. The intermediate frequency is 1600 kc., which is about the lowest frequency free of interference which still can be fed into a communications receiver. Furthermore, its use makes the oscillator tune from 1690 to 2200 kc., which is on familiar ground.

The photographs show the appearance of the finished job. It is mounted on a 9 by 7 by 2-inch chassis which in turn is fitted into a 10 by 7 by 7½-inch cabinet.

A 6K8 is used as oscillator and mixer. The low-frequency inductances are honeycomb coils pared

* 1820 Boulevard, West Hartford, Conn.

¹ Woodward, "Hetrofil — An Aid to Selectivity," *QST*, September, 1939.

down to the correct inductance. If these coils are not available in the junk box, they can probably be found on the bargain table at the local radio store, or of course they can still be purchased from new stock. The oscillator coils are broadcast coils cut down to the proper size as described later. An aluminum baffle shields these from the detector coils. The output transformer is a broadcast i.f. unit rewound as indicated.

The tuning condenser will be seen to have three sections, but this is simply the result of using junk-box parts. Only a two-section condenser is required. The condenser should have a maximum capacity of 365 $\mu\text{fd.}$ for each section, which is a standard b.c. receiver rating. The constants for coils and padders are figured for this value and for a minimum capacity of 50 $\mu\text{fd.}$ per section. If the minimum is lower than this (including the trimmer on the condenser itself) then small fixed micas C_2 and C_7 should be added to make up the deficiency.

On the front of the cabinet is the main tuning

knob and switches for a.c. power, band-switching and for disconnecting the converter and permitting ordinary use of the receiver. The dial plate is probably more pretentious than most amateurs would care to construct, but it is not too difficult to make. It is made of $\frac{1}{16}$ -inch aluminum, with the calibration scale and graduations deeply scratched in with a pair of dividers and scribe. The lettering and numbers are stamped on with steel marking dies. After all the marking is completed the ridges around the letters are smoothed down with fine emery or sand paper and a satin finish obtained by alternate immersing in alkali cleaner (household Oakite or lye will do) and 1:1 nitric acid with water rinses between. The plate is then sprayed with a dull japan (a brushing lacquer could be used) and baked. The impressions are finally filled with a white lacquer filler.

A simpler dial could be made by filling the impressions on bright aluminum with India ink, and a still greater simplification would be to use an inked scale on heavy cardboard and cover the

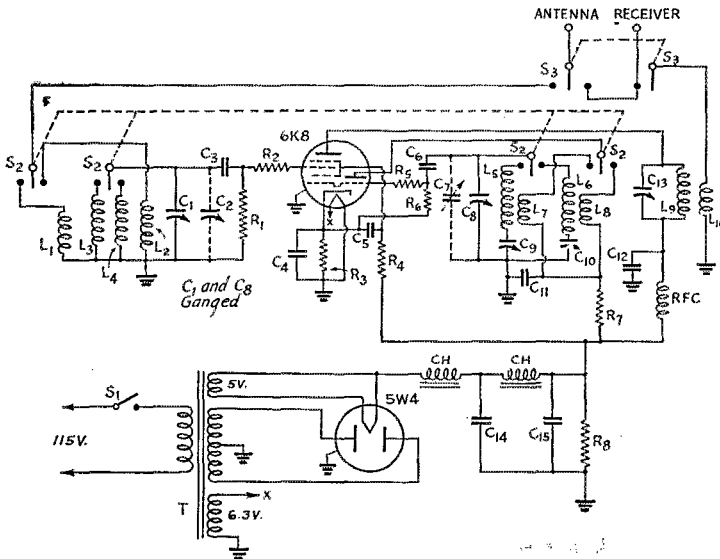

Fig. 1 — Circuit Diagram of the Low-Frequency Converter.

- C_1, C_8 — Two-gang variable condenser, 365 $\mu\text{fd.}$ each section.
- C_2, C_7 — Trimmer as required (see text).
- C_3 — 600- $\mu\text{fd.}$ mica.
- C_4, C_{11}, C_{12} — 0.1- $\mu\text{fd.}$, 400-volt.
- C_5 — 0.05- $\mu\text{fd.}$, 400-volt.
- C_6 — 100- $\mu\text{fd.}$ mica.
- C_9 — 100- $\mu\text{fd.}$ trimmer, set at 72 $\mu\text{fd.}$
- C_{10} — 100- $\mu\text{fd.}$ trimmer, set at 90 $\mu\text{fd.}$
- C_{13} — 100- to 150- $\mu\text{fd.}$ trimmer (see text).
- C_{14}, C_{15} — 8-8- $\mu\text{fd.}$ electrolytic, 525 max. volts.
- R_1, R_6 — 50,000 ohms, $\frac{1}{2}$ -watt.
- R_2 — 25 ohms, $\frac{1}{2}$ -watt.
- R_3 — 250 ohms, $\frac{1}{2}$ -watt.
- R_4 — 20,000 ohms, 2-watt.
- R_5 — 15 ohms, $\frac{1}{2}$ -watt (or two 25-ohm units in parallel).
- R_7 — 25,000 ohms, $\frac{1}{2}$ -watt.
- R_8 — 20,000 ohms, 10-watt.

- L_1, L_2 — See text.
- L_3 — 8620 $\mu\text{h.}$, honeycomb coil cut to 385 turns.
- L_4 — 1385 $\mu\text{h.}$, honeycomb coil cut to 156 turns.
- L_5 — 150 $\mu\text{h.}$, 95 turns No. 30 enameled on 1-inch form.
- L_6 — 108 $\mu\text{h.}$, 72 turns No. 30 enameled on 1-inch form.
- L_7 — 18 turns No. 28 d.s.c., $\frac{1}{8}$ inch from L_5 .
- L_8 — 14 turns No. 28 d.s.c., $\frac{1}{8}$ inch from L_6 .
- L_9 — 110 turns No. 28 d.s.c. on $\frac{1}{8}$ -inch form.
- L_{10} — 10 turns No. 28 d.s.c. at end of L_9 .
- S_1 — S.p.s.t. switch.
- S_2 — 4-pole double-throw switch (Mallory 3142J).
- S_3 — 2-pole double-throw switch (Centralab 1462).
- T — Replacement power transformer 325 volts c.t.; 5-volt rectifier, winding and 6.3-volt filament winding (Stancor M-1506).
- CH — 7 Henry 40 ma. choke (see text).
- RFC — 2.5-mh. choke.

dial with a piece of clear photographic film (cellulose acetate) to keep it clean. Don't use ordinary celluloid (cellulose nitrate) or some day when you are tuning the gadget with a lighted cigarette in your hand a nice fire and possibly a bad burn will result. But in any event, make a calibrated dial—it is well worth the trouble.

The dial indicator is a Johnson transmitting condenser handle with the handle end cut off and the hub faced down. It is mounted on the condenser shaft with a $2\frac{1}{2}$ inch knob.

At the rear of the cabinet a Millen 5-post terminal block furnishes connections to the antenna, ground, the antenna on the receiver, and the a.c. line. Make sure the latter two terminals are protected with tape or rubber sleeves, or fuses in the house circuit will be blown sooner or later.

All other fixed condensers and resistors are mounted underneath the chassis in the most convenient locations to assure short leads. Grounds can be made at the nearest available point and need not be brought to a single point as is often done on the higher frequencies. R_2 and R_3 are not absolutely necessary but do assist in stabilizing the circuits.

The power supply incorporated in the converter is a great convenience in using the unit with any receiver, since it is unnecessary to cut into the receiver circuits for power. A 5W4 is used as the rectifier, a low filament-current tube being desirable to reduce heating and drift. The chokes are small speaker output transformers, the primaries only being used. These can generally be found on the bargain table for about 29 cents each, but the parts list suggests suitable new components. The total current drain of the converter is about 15 ma. plus about 12 ma. for the bleeder.

Tuned Circuits

The data given in the list of parts for the constants of the coils and condensers should be adhered to as closely as possible for good tracking of the circuits. However, the trimmers afford enough adjustment to take care of any but large variations. The two frequency ranges are theoretically 90 to 242 kc. and 225 to 605 kc. with the tuning condenser specified.

L_3 , the inductance for the lowest frequency range, should be 8620 microhenries. This can be obtained by cutting down a 500- or 400-turn honeycomb coil to 385 turns. L_4 , for the higher frequency range, should be 1385 microhenries. A 150-turn honeycomb has an inductance slightly under this value (about 1300 microhenries) but can be used satisfactorily. If you have a 250- or

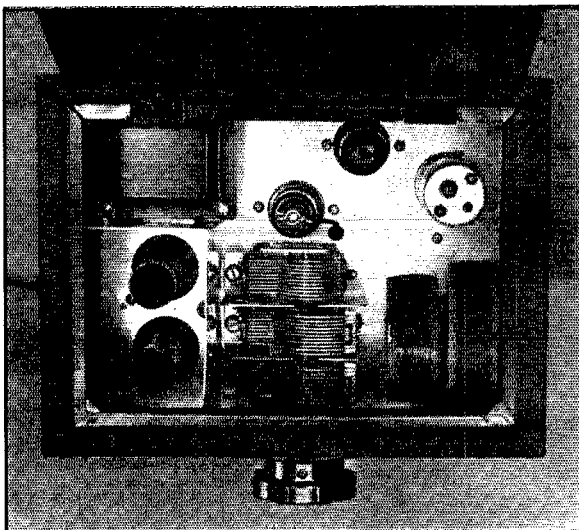

The honeycomb coils are used for the signal-frequency circuit; oscillator coils are ordinary solenoids. This top view shows how the components are arranged on the chassis.

200-turn coil, unwind it to 156 turns and you should be "on the nose."

The antenna coupling coils, L_1 and L_2 , were originally 40 turns of No. 28 d.s.c. closely wound on the outside of L_3 and L_4 respectively. As would be suspected, this was much too tight coupling and trouble was experienced with images and "birdies" from the broadcast stations. By the simple expedient of crisscrossing these coils so that the one wound on L_4 served as the coupling for L_3 , and vice versa, satisfactory results were obtained. It probably would be advisable to experiment somewhat with the size of L_1 and L_2 to secure best results with the actual antenna to be used.

The low-frequency oscillator coil, L_5 , should be 150 microhenries. If you are cutting down a broadcast coil, check with a *Lightning Calculator* to get the correct value. If a new coil is wound, 95 turns of No. 30 enameled, close-wound on a 1-inch diameter form, will be right. The tickler coil, L_7 , is 18 turns of No. 28 d.s.c. spaced $\frac{1}{2}$ inch from the bottom of L_5 .

The other oscillator coil, L_6 , calls for 108 microhenries and can also be cut down from a broadcast coil. Starting fresh, use 72 turns of No. 30 enameled close-wound on a 1 inch form with the tickler, L_8 , composed of 14 turns of No. 28 d.s.c.

Of course, if an a.c. bridge is available the inductance of all coils can be checked and adjusted, but the *Lightning Calculator* will be found close enough for all practical purposes. Both methods were used and found to agree very well.

The series tracking condensers, C_9 and C_{10} , should be set to 72 and 90 $\mu\text{fd.}$, respectively, but this will take care of itself in aligning the con-

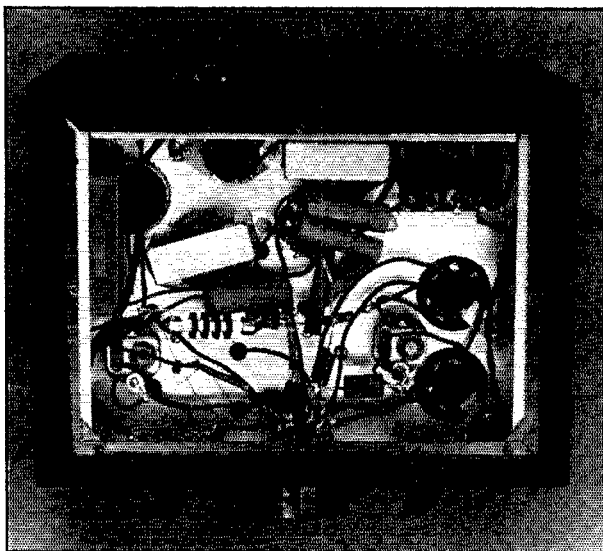

A bottom view of the chassis. Resistors, by-pass condensers, switches, and the power-supply filter are in this compartment.

verter. These condensers are in a double mica unit of about 100 μfd . maximum capacity, the same as used in i.f. transformers, and are mounted so they can be adjusted from above the chassis.

L_9 in the output transformer can be from 100 to 150 microhenries. Fit a $\frac{7}{8}$ -inch form into the old i.f. transformer over the wooden core generally present and wind it with 110 turns of No. 28 d.s.c. wire, or use the *Lightning Calculator* again to fit what you have on hand. L_{10} is 10 turns wound over the lower end of L_9 . C_{13} is both sections of the i.f. variable condenser tied together in parallel. The value needed is about 100 μfd .

Adjustments

After the unit is wired and otherwise completed the oscillator should be checked for proper range, using a calibrated receiver. Turn on the a.c. power switch and set the band switch to the lowest-frequency range. With the main tuning condenser at maximum setting, look for the oscillator signal on the receiver. When it is located, adjust the series padder C_9 to make the oscillator frequency exactly 1690 kc. Next turn the tuning condenser to minimum and adjust the frequency of the oscillator to 1842 kc. by means of the parallel trimmer on the tuning condenser. These adjustments are not entirely independent of each other, so check back and forth several times until they are both correct. It may be necessary to add a small fixed condenser or a combination of several in series at C_7 in order to get the proper minimum capacity.

Now change to the higher band and go through the same procedure. With the tuning condenser at maximum, adjust C_{10} so the frequency of the

oscillator is 1825 kc. When the tuning condenser is then set to minimum the frequency should be 2205 kc.; if not, then one or both of the coils has the wrong inductance and you will have to add or take off turns from one of them.

After the oscillator coils and condensers are properly adjusted the dial may be calibrated. To do this, simply set the receiver at even frequencies such as 1700, 1750, 1800, etc., and mark the settings of the main tuning condenser to give these oscillator frequencies. The graduations on the dial, however, should be 1600 less than these figures so the points will be 100, 150, 200 kc., etc. In this manner the dial can be marked every 10 kc. from 90 to 600 kc.

The converter should then be connected to the antenna and ground terminals on the receiver, an antenna brought to the converter and the receiver tuned to exactly 1600 kc. Adjust the output transformer condenser

C_{13} for maximum noise response, then look for signals. When you find one, peak the trimmer C_2 and further peak C_{13} for maximum response. This should take care of both ranges, but a compromise adjustment of C_2 may be necessary. Here in West Hartford the Hartford aviation beam "HT" on 329 kc. puts in a nice steady signal 30 db above S9 and assists in aligning the tuned circuits.

No other adjustments should be required, and the converter is ready to go to work. As to results — used in conjunction with an HQ120, marine beacons have been heard from Nova Scotia to South Carolina and aviation beams 600 miles away — all low-power stations. Ship-to-shore traffic all up and down the coast and well out in the Atlantic can be followed. One word of advice: use a good antenna. It may be all right to touch an ice pick to the antenna terminal of a high-frequency receiver and get good results, but a low-frequency set requires an honest-to-goodness antenna — at least of 80-meter size.

OUR COVER

The doghouse on stilts that graces our cover this month isn't the editor's private retreat but the antenna used at Riverhead to pick up the television relay from Rocky Point. The antenna is of the parabolic type, protected from the elements by a plywood housing.

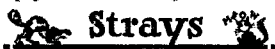

New Voltage Regulator

RCA announces the VR75-30, a glow-discharge regulator similar to others in the VR series with the exception of the operating voltage of 75.

F.M. Limiter Performance

Experimental Determination of Optimum Operating Conditions for Weak-Signal Reception

BY G. H. BROWNING*

The part played by the limiter in the f.m. receiver is an extremely important one. It must iron out all amplitude variations before the signal is passed on to the detector, so that no conventional amplitude detection will take place. Here's some experimental data on limiter operation.

THE design of a receiver for frequency modulation reception differs in many respects from that of the conventional receiver for amplitude modulation. Although the superheterodyne-type receiver is used, modifications are made and new principles are incorporated. In particular, the limiter and detection circuits perform new functions distinctive of f.m. reception.

Before we examine from a practical standpoint the performance of the limiter circuit, the main subject of this discussion, let us pause briefly to explain the action taking place in the limiter and the detector.

The limiter is designed to keep the amplitude of the signal fed to the detector as nearly constant as possible. The result of this constant signal amplitude is twofold. First, noise and even tube hiss are greatly reduced, because most interference is of such nature as to manifest itself as an amplitude change in the receiver. Since the frequency-modulated signal itself has constant amplitude, limiting the signal in amplitude has no effect on the transmission quality.

The second result of constant signal amplitude into the detector is that the audio voltage output developed by the detector is substantially constant for a given frequency deviation of the signal. Thus the limiter acts as an automatic volume control, and in ordinary circumstances no other a.v.c. need be employed. For the limiter to function, a certain minimum signal must be impressed on its input circuit, but after this minimum value of signal has been reached the detector signal voltage does not change materially as the signal input is varied over a wide range. It is most essential

from the standpoint of noise elimination to have sufficient signal impressed on the limiter.

The i.f. transformer which feeds the two diode sections of the detector is so designed that, in combination with the diodes, frequency deviations from the center frequency of the transmitter result in voltages between point A (Fig. 1) and ground which are proportional to the frequency deviation. That being the case, it is readily seen that if the rate of frequency deviation of the transmitter is in the audio range, audio frequency voltage will be developed between the cathodes of the diodes. These audio voltages may then be fed to a conventional audio amplifier system.

Limiter Performance Data

Let us now examine the limiter circuit in some detail and answer by performance data such questions as: May the limiter grid current be used to indicate relative signal strength? (Limiter current is measured by a meter in the grid return of the limiter tube as shown in Fig. 1.) How do the voltages developed across the diode cathodes vary with limiter grid current? How do the voltages developed across the cathodes change as the transmitter's frequency deviates from its center frequency? (The louder the sound impinging on the microphone at the transmitter, the greater the deviation of the transmitter's frequency.) What is the minimum limiter grid current required for substantial noise reduction? What noise reduction can be obtained? And last, but not least, how does the limiter operate and what circuit constants give satisfactory performance?

To determine how nearly linear the current in the limiter grid circuit is with signal input, a 3-Mc. signal was fed directly to the grid of the mixer of an f.m. receiver using that intermediate

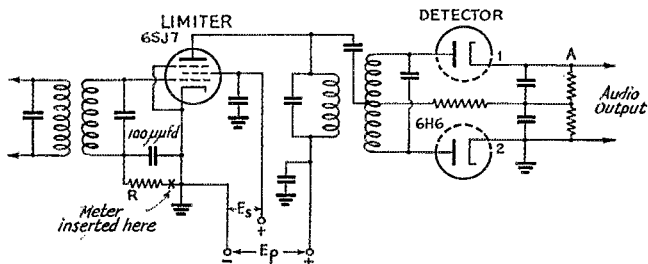

Fig. 1 — The f.m. limiter and detector (discriminator) circuit discussed in the text.

* 750 Main St., Winchester, Mass.

frequency, and the limiter current determined for various input signal voltages. The reason for feeding the signal directly into the i.f. amplifier at 3 Mc. rather than into the r.f. system at fre-

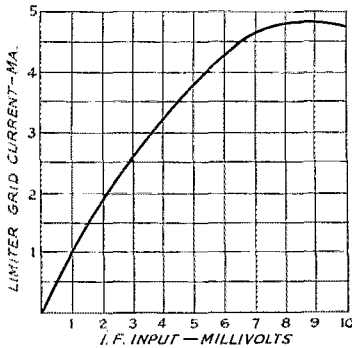

Fig. 2 — Limiter grid current plotted against r.f. voltage input to the intermediate frequency amplifier. Limiter grid resistance (R , Fig. 1) 10,000 ohms; E_s , 75 volts; E_p , 25 volts.

quencies in the 40-Mc. band or higher was because attenuators on signal generators at these high frequencies are not as reliable as at 3 Mc. The data obtained are shown in Fig. 2, where the limiter current is plotted against a 3-Mc. input signal measured in millivolts. It will be noted that the limiter grid current is somewhat linear with millivolts input until a saturation point is reached which, in the case of the circuit used, occurs at about 4.8 ma. This saturation probably is caused by overloading of the preceding r.f. stages at high signal input. The magnitudes of the values both of limiter grid current and signal input voltage would of course vary materially with the gain in the i.f. amplifier and numerous other factors. However, the important information obtained by means of these data is that up to a certain signal strength the limiter current is nearly proportional to signal strength.

Before discussing the data concerning the voltage developed across the cathodes of the detector as compared with limiter current, it should be

understood that the detection circuit is so aligned that when the 3-Mc. signal is fed into the i.f. amplifier, zero voltage is developed across the cathodes. If the signal frequency varies from 3 Mc., d.c. voltages will appear between the cathodes. At frequencies higher than 3 Mc. cathode No. 1 will be negative with respect to cathode No. 2, which is grounded. On the other hand, if the signal frequency is decreased, cathode No. 1 will be positive with respect to ground. The detection transformer is aligned so that equal variations either side of the center frequency produce equal and opposite d.c. voltages in the detector circuit. Thus as the frequency-modulated signal varies in frequency, voltages should be built up across the cathodes which are directly proportional to the frequency variation. These voltages of course vary at an audio rate, resulting in an audio voltage which may be fed to a suitable audio amplifier.

To determine the linearity of the detection system and the magnitude of the voltage across the detector cathodes vs. limiter grid current, c.w. frequencies from 2.9 to 3.1 Mc. were impressed on the i.f. amplifier. At various frequencies between these limits the amplitude of the signal was varied and the corresponding limiter currents obtained. This procedure resulted in the family of curves shown in Fig. 3.

With a 3-Mc. signal fed into the i.f. amplifier, no voltage could be built up between the detector cathodes, but as the frequency is increased or decreased from 3 Mc. equal and opposite voltages were developed, their magnitude being determined by the deviation from 3 Mc. We are particularly interested in finding the minimum limiter grid current above which we get substantially no change in voltage output. It is clearly shown in Fig. 3 that this point occurs at about 400 microamperes, in the receiver under consideration, and that higher values of limiter current give substantially no change in voltage output. It will be noted that if the limiter current is 400 microamperes or more the voltages are substantially linear as the frequency deviates from 3 Mc., being 10 volts per 20 kc. of deviation.

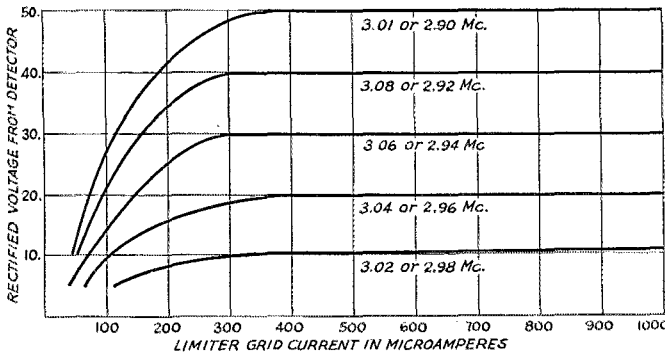
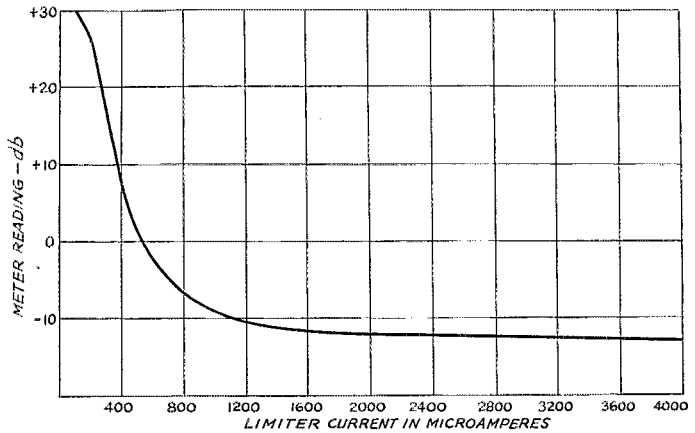

Fig. 3 — Rectified d.c. voltage developed across cathodes of the detector diodes as a function of limiter grid current, for various frequency deviations from the center frequency of 3 Mc.

Fig. 4 — Noise in a.f. output of the receiver as a function of carrier strength, measured by rectified grid current in the limiter.



One of the fundamental advantages of broadband frequency modulation is the reduction in noise. A great deal of this noise reduction takes place in the limiter and detector circuits. Thus experimental data should readily show the relative magnitude of noise reduction as the signal strength is increased. To obtain information on this noise reduction effect, a frequency-modulation receiver tuned to 43 Mc. was placed in operation. A db meter was connected to the output of the audio amplifier. A short antenna was used for picking up interference generated by a universal motor. But even when the universal motor was stopped the tube hiss was extremely pronounced because of the high gain in the i.f. and r.f. sys-

tems, giving a reading between 16 and 20 db. The output from an unmodulated signal generator giving a 43-Mc. signal was clipped to the insulated antenna lead-in, thus giving a small amount of capacity coupling between the signal generator and the antenna input. With the output of the signal generator retarded to as near zero as possible, the noise developed from hiss and the universal motor caused the output meter to read 30 db. The limiter grid current from this noise alone was approximately 100 microamperes. The output from the signal generator was then increased so that the limiter current was 400 microamperes, and there was a drop of 22 db in output noise. As

(Continued on page 85)

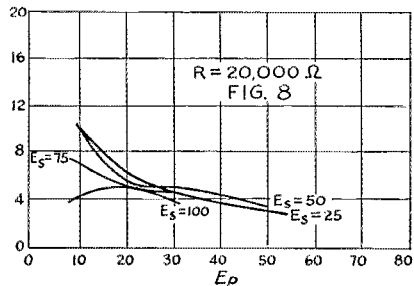
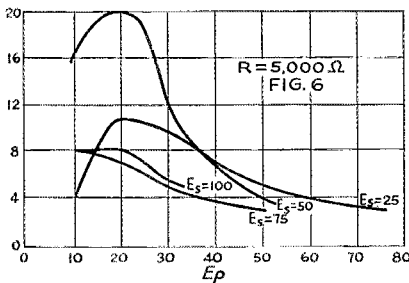
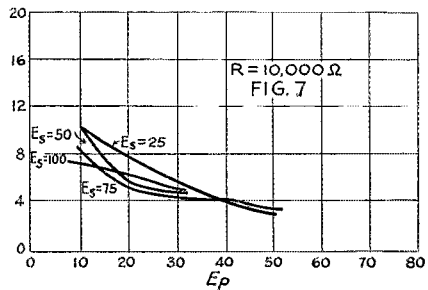
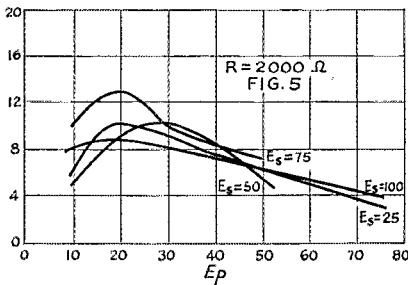

Fig. 5-8, inc. — Comparative signal-to-noise ratios on a weak signal when the limiter operating conditions are varied.

★ WHAT THE LEAGUE IS DOING ★

ELECTION NOTICE

To all members of the American Radio Relay League residing in the Central, Hudson, New England, Northwestern, Roanoke, Rocky Mountain, Southwestern and West Gulf Divisions:

You are hereby notified that, in accordance with the constitution, an election is about to be held in each of the above-mentioned divisions to elect both a member of the A.R.R.L. Board of Directors and an alternate thereto for the 1941-1942 term, except that in the case of the Southwestern Division the election will be for an alternate only. Your attention is invited to Sec. 1 of Article IV of the constitution, providing for the government of A.R.R.L. by a board of directors; Sec. 2 of Article IV, and By-Law 12, defining their eligibility; and By-Laws 13 to 24, providing for the nomination and election of division directors and their alternates. Copy of the Constitution & By-Laws will be mailed any member upon request.

Voting will take place between November 1 and December 20, 1940, on ballots that will be mailed from the headquarters office in the first week of November. The ballots for each election will list, in one column, the names of all eligible candidates nominated for the office of director by A.R.R.L. members residing in that division; and, in another column, all those similarly named for the office of alternate. Each member will indicate his choice for each office.

Nomination is by petition. Nominating petitions are hereby solicited. Ten or more A.R.R.L. members residing in any one of the above-named divisions may join in nominating any eligible member of the League residing in that division as a candidate for director therefrom, or as a candidate for alternate director therefrom. No person may simultaneously be a candidate for the offices of both director and alternate. Inasmuch as the by-laws were recently amended to transfer all the powers of the director to the alternate in the event of the director's death or inability to perform his duties, *it is of as great importance to name a candidate for alternate as it is for director.* The following form for nomination is suggested:

Executive Committee

The American Radio Relay League
West Hartford, Conn.

We, the undersigned members of the
A.R.R.L. residing in the
Division, hereby nominate
....., of, as a candi-
date for DIRECTOR; and we also nominate

....., of, as a candi-
date for ALTERNATE DIRECTOR; from
this division for the 1941-1942 term.

(Signatures and addresses)

The signers must be League members in good standing. The nominee must have been both a member of the League and a licensed radio amateur operator for a continuous term of at least four years immediately preceding receipt by the Secretary of his petition of nomination, except that a lapse of not to exceed ninety days in the renewal of the operator's license and a lapse of not to exceed thirty days in the renewal of membership in the League, at any expiration of either during the four-year period, will not disqualify the candidate. He must be without commercial radio connections: he may not be commercially engaged in the manufacture, selling or renting of radio apparatus normally capable of being used in radio communication or experimentation, nor commercially engaged in the publication of radio literature intended, in whole or part, for consumption by licensed radio amateurs. Further details concerning eligibility are given in By-Law 12. His complete name and address should be stated. The same requirements obtain for alternate as for director. All such petitions must be filed at the headquarters office of the League in West Hartford, Conn., by noon E.S.T. of the 20th day of October, 1940. There is no limit to the number of petitions that may be filed on behalf of a given candidate but no member shall append his signature to more than one petition for the office of director and one petition for the office of alternate. To be valid, a petition must have the signatures of at least ten members in good standing; that is to say, ten or more members must join in executing a single document; a candidate is not nominated by one petition bearing six signatures and another bearing four. Petitioners are urged to have an ample number of signatures, since nominators are frequently found not to be members in good standing. It is not necessary that a petition name candidates both for director and for alternate but members are urged to interest themselves equally in the two offices.

Present directors and alternates for these divisions are as follows: Central Division: director, R. H. G. Mathews, Chicago; alternate, E. W. Kreis, W9HRM. Hudson Division: director, Kenneth T. Hill, W2AHC; alternate, Robert M. Morris, W2LV. New England Division: director, Percy C. Noble, W1BVR; alternate, Russell Bennett, W1GTN. Northwestern Division: director, Ralph J. Gibbons, W7KV; alternate, W. N.

Wintler, W7KL. Roanoke Division: director, H. L. Caveness, W4DW; alternate, J. Frank Key, W3ZA. Rocky Mountain Division: Glen R. Glasscock, W9FA; alternate, C. W. Duree, W9EII. Southwestern Division: alternate and acting director, John E. Bickel, W6BKY. West Gulf Division: director, William A. Green, W5BKH; alternate, none. A special election is already in process to choose a Southwestern Division director.

These elections constitute an important part of the machinery of self-government in A.R.R.L. They provide the constitutional opportunity for members to put the direction of their association in the hands of representatives of their own choosing. Members are urged to take the initiative and to file nominating petitions immediately.

For the Board of Directors:

K. B. WARNER,
Secretary

August 1, 1940

HELP WANTED IN MONITORING

WASHINGTON is a busy place these days, government offices are burning much midnight oil, and new agencies are entering the picture. You have doubtless read in the press of the plans for creating a Defense Communications Committee, to consist of the ranking communications officers of F.C.C., Army, Navy, State Department and the Coast Guard. The plans are all drafted but up to this writing the opinion has prevailed that the communications art and industry have taken care of themselves very well and that there is not yet need for such a committee. The League maintains close contact at Washington on behalf of amateur radio and finds all branches of the government professing to be satisfied with the present status of hams.

F.C.C. is engaging in a vast expansion of its monitoring activities to track down any unauthorized radio activities in this country. A hundred new four-man monitoring stations are being created and about 500 new people are being taken on. Last month we gave you the addresses of the F.B.I. offices and suggested that, if you should be improperly approached for communication facilities, you should report the circumstances to F.B.I. However, radio signals heard on the air should not be reported to F.B.I. but to F.C.C. If you hear any "hot" stations or screwy stuff on the air, report the dope at once to the nearest office of F.C.C.

F.C.C. needs additional radio operators immediately for its expanded monitoring service and has sent out a call for skilled radio amateurs who would be interested in accepting employment. The pay is \$1620 a year. The A.R.R.L. directors and their alternates and assistants, and the SCM's and RM's and PAM's of the League and the secretaries of our affiliated clubs all have the dope in detail; if interested, communicate with

the one nearest. In brief, an amateur applicant must have been continuously licensed for the preceding five years, must be between 21 and 55 years of age, will be required to demonstrate ability to transmit and receive plain English at 20 words per minute, must be able to comply with Order No. 75 with respect to citizenship and fingerprints, must be able to pass a physical examination, and must pay his travel expenses to the city or town of his appointment. Application should be made on Civil Service Application Form No. 8 and Supplemental Form 2902. The Civil Service has branches in a dozen major cities where these forms are to be obtained. In all other cities having a first-class or second-class post office the forms may be obtained from the post office, where there is a Civil Service secretary. See your nearest A.R.R.L. field official for further particulars.

CITIZENSHIP SHOWING

F.C.C. has knocked out its blanks for the proof of citizenship at pretty good speed. With plenty of individual difficulties, amateur radio is responding without too much grumbling. The F.C.C. has set up a new office at its Washington headquarters to deal with this subject and with the numerous cases requiring individual correspondence. When the supply of new forms was distributed to all of the 26 field offices of F.C.C., a zero hour was reached, after which licenses were not issued until the citizenship showing was made. Thus there were many hundreds of amateur applications caught in process and these are the subject of special correspondence, the applicant receiving the forms from the Commission with the word that he must prove his citizenship before the license is issued.

If you know anybody who has an application pending for a *new* license, tell him to write his inspector immediately and get the forms for proof of citizenship, complete them and send them to F.C.C. at Washington, with a letter asking that they be attached to his pending application, stating the place and date where he took the exam.

Only one such showing is required of any individual, regardless of the number of licenses he holds. Many amateurs who work commercially, as in broadcasting stations, thus have made their showing by means of a proof filed primarily on behalf of their commercial tickets.

From now on, every applicant for a new amateur license must file this showing. When you get the regular license application blank from your inspector, you also receive a special questionnaire, fingerprint card, instructions, etc. If you are a new applicant living within 125 miles airline of an examining point, and are to appear in person for examination for Class B or A, fill out the forms and have the required papers with you and

(Continued on page 82)

The T-Matched Antenna

Feeding the Radiator With An Untuned Line

BY JOHN D. KRAUS,* W8JK, AND
STOCKER S. STURGEON,** WBMPH

THE delta or "Y-matched" system is widely used to connect an open-wire untuned transmission line to a half-wave antenna. This familiar arrangement is shown in Fig. 1.

The use of the "Y" or fanned-out section between the transmission line and the antenna is convenient in some cases. However, there are many installations where it would be more convenient to extend the transmission line at uniform spacing to within a very short distance of the antenna. An arrangement of this type is provided by the "T match" shown in Fig. 2-A. The transmission line divides at a point close to the antenna, and each wire extends parallel to the antenna for a short distance before making a right angle bend and connecting to the antenna.

Referring to Fig. 2-A, L is the length of the antenna, D the distance along the antenna between the points where the line connects to it, A the distance from each end of the antenna to the nearest tap, and S the spacing between the antenna and the parallel wire of the "T match". In constructing an antenna it is only necessary that either A or D be specified. For convenience, however, both are given. Open-wire lines of any convenient characteristic impedance can be used for feeding a half-wave antenna by means of the "T match". For a 600-ohm line, the recommended dimensions are as follows, where f is the operating frequency in megacycles:

$$L = \frac{475}{f} \text{ feet,}$$

$$D = \frac{114}{f} \text{ feet,}$$

$$A = \frac{180.5}{f} \text{ feet,}$$

$$S = \frac{114}{f} \text{ inches.}$$

As an example, an antenna cut for the center of the 14-Mc. band (14.2 Mc.) would have the following dimensions: $L = 33$ feet 5 inches,¹ $D = 8$ feet, $A = 12$ feet 8 inches, and $S = 8$ inches. These dimensions are suitable for matching an

* Arlington Blvd., Ann Arbor, Mich.

** 1032 Vaughn St., Ann Arbor, Mich.

¹ Note that this formula for the antenna length gives a slightly longer length than the usual formula. — Ed.

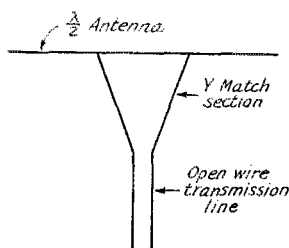

Fig. 1 — Delta or Y-matched half-wave antenna.

open wire line having a characteristic impedance of about 600 ohms. A line of this impedance can be constructed of No. 12 wire, spaced about 6 inches.

The performance of the "T" match is excellent and is entirely comparable with the delta or Y match. Tests involving changes of several variables have been made with T-matched horizontal half-wave antennas at W8JK. These variables included antenna dimensions, frequency and height above ground. A variation of only about 10 per cent in the standing-wave ratio on the transmission line was observed over the frequency range of the 14-Mc. band.

It appears that the dimension D is not critical. Although the length L is not particularly critical, it is important that it be fairly close to the resonant value. For a simple half-wave antenna made of No. 12 wire, the dimensions given above are close to optimum. If tubing is used for the radiator, it may be desirable to shorten L by about one per cent. When using a T-matched half-wave as the driven element of a beam antenna, some change in D may also be desirable.

An arrangement for supporting the center of the "T match" is shown in Fig. 2-B. Two insulating strips, of paraffined wood or ceramic material, are used to maintain the spacing at the

Although aware of its advantages, many amateurs hesitate to use an untuned transmission line to their antenna because the usual delta match is often awkward and sometimes hard to adjust. Here is a modification of the system that takes up less room and should be much easier to get going.

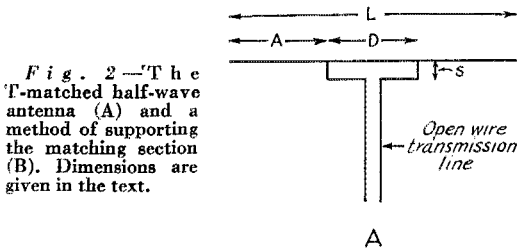

center and to carry the weight of the transmission line. An approximate right-angle bend is made at each end of the "T," adjacent to where the wires connect to the antenna. By using sufficiently heavy wire (No. 12 or heavier) this bend can be made self-supporting.

Two-Wire Antennas

The T-matched half-wave can be regarded as an intermediate step toward the 2-wire half-wave antenna.² An antenna of this type is shown in Fig. 3-A. With the antenna in free space, the resistance at the antenna terminals is about 300 ohms.

Another type of 2-wire radiator is the extended antenna shown in Fig. 3-B. This is a 2-wire three-quarter wave antenna. Both wires are opened at the center, the transmission line connecting across one of them. The feed point resistance is about 450 ohms.

The dimensions given in Fig. 3 are suitable for operation in the 14-Mc. band. For 28 Mc. these dimensions, both length and spacing, should be halved. Thus, for example, a 2-wire half-wave

² J. D. Kraus, "Multi-Wire Doublet Antennas," *Radio*, May, 1939, and June, 1939; and "Multi-Wire Dipole Antennas," *Electronics*, Jan., 1940.

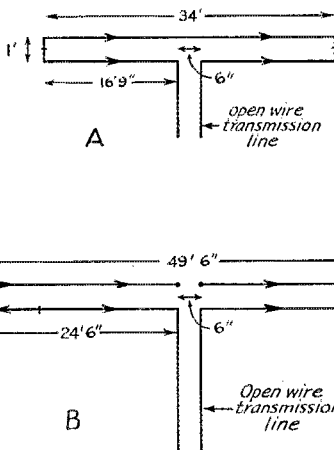

Fig. 3 — The 2-wire half-wave antenna (A) and the 2-wire three-quarter wave antenna (B). Dimensions are given for the 14- to 14.4-Mc. band.

antenna for operation in the 28-Mc. band is made 17 feet long, with 6-inch spacing. The arrows on the wires indicate the current distribution on the antennas at a given instant. The radiation characteristics of the 2-wire half-wave antenna are similar to those of a simple single-conductor half-wave. The principal change is the increase in the feed point radiation resistance from about 70 to 300 ohms. The radiation characteristics of the 2-wire three-quarter wave antenna are similar to those of a single-conductor extended half-wave type. Either of the 2-wire antennas may be fed satisfactorily with open-wire transmission lines of 400 to 600 ohms characteristic impedance. Although the feed point resistance of the 2-wire types may appear on paper to be somewhat low for the direct connection to a 600-ohm line, excellent results can be obtained with such an arrangement. The 2-wire antennas also have the advantage of a very flat response over a wide frequency range.

The 2-wire three-quarter wave antenna is slightly more directional than a half-wave antenna, concentrating more radiation at right-angles to the antenna. However, all of the antennas described in this article, both T-matched and 2-wire types, are much similar to a simple half-wave antenna in radiation characteristics and are not beam antennas in any sense. The antennas described can be regarded as simple types in which the matching arrangement is included as an integral part of the radiating system.

We appreciate the assistance of Henry Newburgh, W8MDA, in certain of the tests on the T-matched half-wave antenna.

Strays

Welcome, a new ham. Bruce Thomas Battey arrived July 14th at the shack of Ev Battey, Assistant Communications Manager, W1UE. The OM has to be very quiet while operating the rig these days, but the youngster already is able to make himself heard. S'pose he'll be a 'phone man?

W9SG and W9SGA, although they started in amateur radio many miles and many years apart, are now next to each other both in the Callbook and in the fact that they share an apartment in Chicago.

Predictions of Useful Distances for Amateur Communication

BY N. SMITH AND S. S. KIRBY*

EXCEPT for the ground wave, over relatively short distances, the useful distance range of radio waves is limited by skip and absorption of the radio waves in the ionosphere. The skip distance is the minimum distance over which radio waves of a given frequency can be received via the regular layers of the ionosphere; for shorter distances the waves penetrate through the ionosphere and are not reflected back to earth. The maximum distance over which radio waves of a given frequency can be received via the ionosphere is determined by absorption of the waves in the ionosphere, the power of the trans-

* National Bureau of Standards, Washington, D. C.

mitter, and local receiving conditions such as static, the quality of the receiving station, and the skill of the operator. The absorption depends on the frequency and the distance the waves travel through the ionosphere. The absorption usually decreases as the frequency increases. It is greater the longer the distance traveled in the ionosphere. It is nearly always present to some extent, and is frequently quite large. For illustration, it might be pointed out that if there were no absorption a signal from a 5-watt transmitter would be readable half way around the earth. The maximum transmission distance determined by absorption is not as sharply defined as the minimum transmission distance determined by skip.

In the two charts herein, predicting average

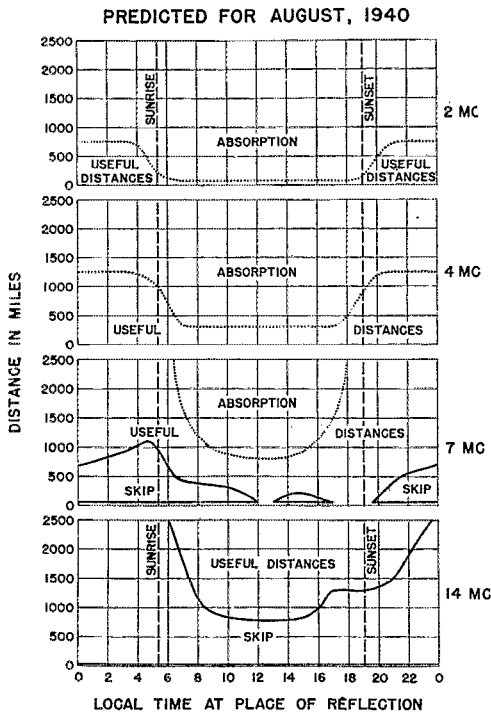

Fig. 1 — Useful distances for radio-wave propagation via the regular layers of the ionosphere, predicted for August, 1940. The skip distances shown will be considerably decreased during frequent irregular periods because of reflections from patches of sporadic-E layer. For the same reason 28-Mc. transmission will be useful over long distances during frequent irregular periods, and 56-Mc. transmission during occasional irregular periods.

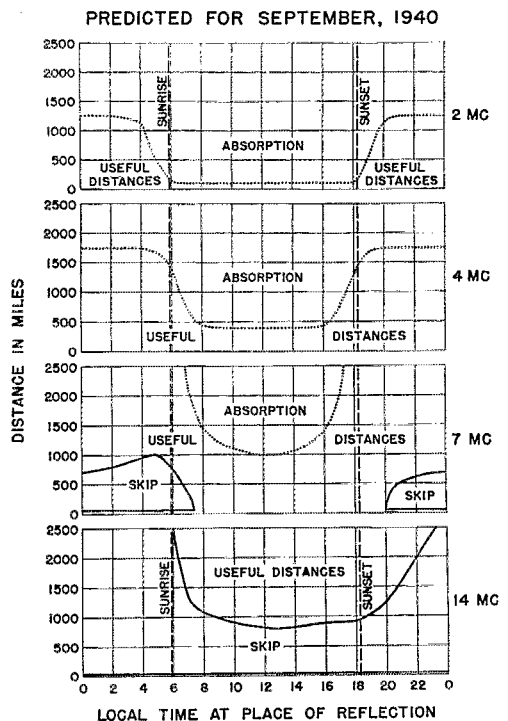

Fig. 2 — Useful distances for radio wave propagation via the regular layers of the ionosphere, predicted for September, 1940. The 28-Mc. and 56-Mc. bands will be useful only for local transmissions (optical and quasi-optical paths).

This paper gives predictions of minimum and maximum distances of transmission in the 2-, 4-, 7-, and 14-Mc. bands for August and September. The predictions are based on past measurements of ionosphere characteristics and radio station intensities and, of course, represent average values. Similar articles will be published quarterly in *QST*—from October to March the 28-Mc. band will be usable part of the time for long-distance communication, and therefore data for that band will be added to the next article.

conditions for the coming August and September, a graph is shown for each frequency band regularly affected by ionosphere transmission. The graphs are plotted to show the useful distances at various times of day. The distances shown are averages for the undisturbed days of the month. The ordinates are transmission distances and the abscissas are local times at the place of reflection. Midnight is indicated by 0, and noon by 12. The solid-line graphs show skip distances. Except for ground waves and sporadic and scattered reflections, transmission over shorter distances than these will not be possible. The dotted lines represent approximately the absorption limit; in general, transmission over greater distances than these will not be good. For example, on the 7-Mc. chart for August, at 8 A.M., ground-wave transmission will be useful out to about 50 miles; from here to about 400 miles transmission by the regular layers will not be possible because of skip. In the range from about 400 to 1200 miles transmission will be useful. In this distance range the intensity of the waves gradually decreases and beyond about 1200 miles, because of absorption, becomes too weak to be useful on the average.

In using the charts, the time to be used is the local time at the midpoint of the path. For example, a station in Nebraska wishing to transmit to Washington, D. C., at 8:00 A.M. C.S.T. (about 7:30 A.M. Nebraska local time and 9 A.M. Washington time) would have to consult the distance range curves for 8:15 A.M., while if he wished to transmit to San Francisco at the same time (6 A.M. San Francisco time) he would have to consult the curves for 6:45 A.M. It should be emphasized, however, that transmission conditions are the same in opposite directions over the same path at the same time. If a station can be heard it can be worked two-way, if the apparatus at the ends is at all similar.

In addition to a knowledge of the diurnal and seasonal variations, a long-time view of variations of radio transmission conditions should be helpful. The maximum in the 11-year sunspot cycle was reached in 1937. This was also a period most favorable to the use of the highest frequencies, such as 28 Mc., for long-distance transmission, and short skip distances prevailed. By the time of the next sunspot minimum (about 1944) the best frequency for a given path, time of day, and time of year will be about half what it was in 1937. In other words, in 1944 the 28-Mc. band will behave as the 56-Mc. band did in 1937, the 14- as

the 28-, the 7- as the 14-, and the 4- as the 7-. For further information on the diurnal, seasonal, year-to-year, and irregular variations of radio transmission dependent on the ionosphere, see the National Bureau of Standards Letter Circular LC575 on the ionosphere and radio transmission conditions, obtainable on request from the National Bureau of Standards.

Code Proficiency Runs from W1AW



August 30th (Friday) and September 21st (Saturday) are the next dates; 8:15 P.M. CST (or the equivalent in your local time) will be the time. Listen on 1761, 3825, 7280, 14,254 or 28,600 kcs. and copy the progressively faster runs which start at the slowest rate at 8:30 P.M. C.S.T. Practice groups are sent from W1AW on the same frequencies daily—except Friday at this time. Certify

you are submitting direct copy from aural reception without any form of assistance. State if you copied by "hand" or "mill" if you submit other than the original.

Certificates will be awarded by the League on initial qualification in a particular speed, requiring only 100% accurate reception for at least one minute of a run at a particular speed. Progress in proficiency in code reception will be shown after the initial test and certificate award, by a separate dated and initialed Silver Endorsement Sticker (a distinctive design for each speed).

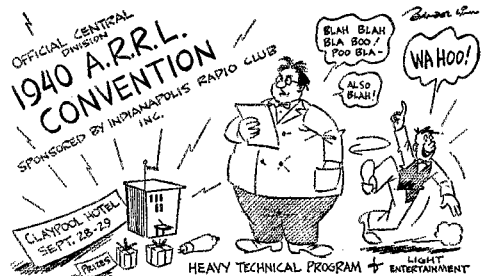

Equipment displays, technical speakers, entertainment for ladies, prizes, dancing, banquet early Sunday evening so that out-of-town guests may drive home. Registration \$2.50 in advance; \$3.00 at the door. Write Box 1583, Indianapolis, Ind.

K7BUB—Ham Paradise in Alaska

Or Why One Ham Went North

WHEN Stan Bennett, W7BUB, went to Alaska to take charge of the new broadcasting station, KFAR, he must have had more than one reason behind his madness — as we shall presently see.

KFAR, hailed in recent press releases as the most northern broadcasting station in the world, was built by Capt. A. E. Lathrop, a pioneer "sourdough," as a memorial to the people of Alaska to provide inhabitants of the interior with their first real broadcast reception. The transmitter is located in a modern concrete structure five miles out of Fairbanks where the studios are situated. A completely up-to-date apartment is included in the building and every provision has been made to guard against winter weather where temperatures often run to 50 and 60 degrees below zero.

One of the most important of the services which KFAR provides is that of supplying the latest news. Since teletype or other wire services

so important in the collection of news are unavailable, it is necessary to depend upon short-wave broadcasts from the States. To make the reception of news as reliable as possible — and here we begin to understand why Stan was willing to leave the comparative comfort of W7 climate — the latest in receiving equipment has been provided. There is a dual-diversity receiver which may be used with either of two 500-foot rhombics, one pointed toward the East Coast of the States and the other bearing on the West Coast. Tests against a half-wave vertical antenna at 14 Mc. showed a gain of 13.5 db. in the favored direction of either rhombic or a power gain of about 22 over the vertical half-wave. Although there is only a 30-degree difference between the bearings of the two coasts from Fairbanks, tests showed a gain of about 15 db. with one rhombic against the other on a signal in the favored direction of the first.

(Continued on page 86)



Center — K7BUB ready for a Sunday-afternoon spin in his 5-d.p. roadster. Left — The ham rig. Bottom — Stan at the operating position. Right — The shack where K7BUB makes hay whether or not the sun shines.

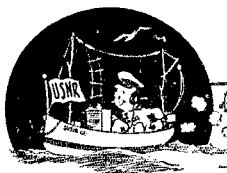

NAVAL COMMUNICATION RESERVE NOTES

The Navy and the Amateur

BY LT.-CMDR.
JOHN L. REINARTZ

EVER since the first World War showed the value of the American radio amateur to the Military Services of the United States, the amateurs have had in the U. S. Navy a friend who has stood them in good stead when International Radio Conferences threatened to take away their heritage; the frequencies they use in their daily intercommunication and during regional emergencies.

The U. S. Navy has had a hand in the development of every phase of radio; military, commercial and amateur. It has seen the small beginning and the tremendous growth of radio in all its branches. Particularly does it harbor a warm spot in its heart for the American amateurs who have done so much to point out the usefulness of those higher frequencies previously assumed to have no military or commercial value.

The U. S. Navy early saw the advantage of a reserve communication organization composed largely of members of the American radio amateur fraternity, the American Radio Relay League. Such a reserve organization was brought into being in 1925 and the progress made by the Naval Communication Reserve since its inception is one of which its members can be justly proud. It also substantiates the faith of those who predicted that it could be done on a voluntary basis by the citizens of the United States.

The Naval Communication Reserve, a paper organization in 1925, came into its own in 1929 when a radio net was established between Washington and all the continental Naval Districts. Since radio communication was something the officers and men understood, there quickly resulted so much radio activity that it became practicable for the Commandants to set up additional radio circuits for the radio training activities in their respective districts. Navy frequencies were limited in number and restricted as to use. District radio activities were mostly conducted on amateur frequencies until the need for additional Naval frequencies were indicated and were allowed as needed.

That foresight was shown by the Navy Department in the establishment of the Naval Communication Reserve, to meet the needs for communication personnel in the event of a National Emergency, is now evident. The cooperation of

the American radio amateur with the military services of the United States has rounded out to the benefit of both. The very existence of the radio amateur is based on the principle of voluntary service in emergencies requiring communication facilities not available or destroyed during flood, fire or storm. Obviously the military services of the Government can be expected to preserve an agency so useful during times of peace, and so invaluable in time of war, and have done so.

The time has now come when the American radio amateur who has not affiliated himself with one of the military services of the United States should make an endeavor to do so, for he is peculiarly fitted for the duties of communication as no other citizen is, and the need for additional communication personnel becomes more obvious every day as the Fleet is expanded and the forces of the Army are increased. Assuredly the amateurs will meet this demand.

New Hampshire State Convention

(New England Division)

September 21, 1940

Hotel Carpenter, Manchester, N. H.

Write George Perkins, W1IVU, 129 Almond St., Manchester, N. H., for further details.

Silent Keys

It is with deep regret that we record the passing of these amateurs:

John Wallace Acuff, W4DE, South Jacksonville, Fla.

William E. Adkins, W8DIX, New Boston, Ohio

Herbert J. Barries, W3BEH, Roslyn, Penna.

James Darby, ex-5DJQ, Pine Bluff, Ark.

Fred L. Dewey, W6DU, Alpine, Calif.

Harry Knowlton, Jr., W8EFJ, Franklin, Ohio

Hobart B. Stover, W9GEX, Fond du Lac, Wis.

Allan E. Vosburg, Jr., W8QGD, Detroit, Mich.

Frank M. Webb, W9ZVA, Hermann, Mo.

Automatic Tuning for the Amateur Transmitter

Mechanical Alignment for All Types of Circuit Layouts

BY W. M. "BILL" ATKINS,* W9TJ AND C. T. READ,** W9AA

THE keynote of modern radio construction seems to be, "Push a button and watch it happen." Witness the modern rotary beam antenna . . . we push a button, the beam revolves and signals spout out in the desired direction. Now consider the modern receiver . . . we push a button or turn a knob and the receiver jumps from one band to another. A single dial tunes a multiplicity of stages! Very simple and completely modern.

Now let's look at the transmitter. Considering the trend in other radio fields, we would expect to find the present-day transmitter a classic example of modernity plus! We might even go so far as to expect a modern transmitter to be a single-control affair, capable of instantaneous operation on any frequency in the five popular amateur bands, as flexible and as easy to handle as a modern receiver.

Instead, our expectations are blasted when we discover the modern transmitter to be a cumbersome piece of equipment having a multitude of dials, knobs and buttons, each requiring careful

adjustment for any change in band or for changes in frequency within each band. Certainly there is nothing modern about equipment that is responsible for the loss of valuable time and energy. Considering the present-day transmitter, it isn't hard to understand why each amateur operator has his "pet" band. Operating time is usually limited and the average amateur has no desire to spend this time in changing bands and retuning his multi-stage rig.

But this venture into the field of literary endeavor is not prompted entirely by the desire to ridicule transmitter design. We can dispense with criticism of present construction standards and describe a system of automatic tuning applicable to any radio transmitter, regardless of its size, power or construction, proving that the amateur radio transmitter can be made as flexible and as easy to handle as a modern receiver.

When the subject of automatic tuning is mentioned the average amateur immediately has visions of complicated relay circuits, motor drives, expensive banks of pre-tuned tank circuits and ganged condensers—plus tracking difficulties that would baffle a magician. Various types of auto-

* Box 73, Raymore, Mo.

** 507 West 62nd St., Chicago, Ill.

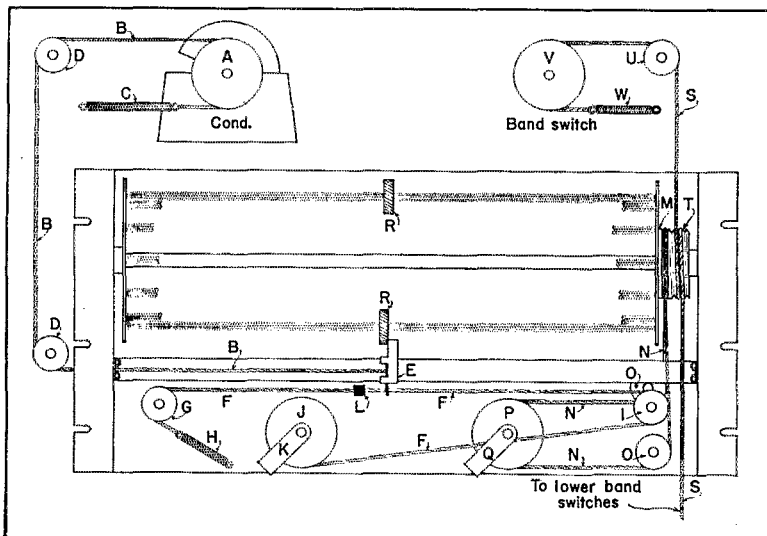

Fig. 1 — Schematic drawing of the control system showing the method by which switches and tuning condensers are shifted to predetermined positions.

Most "one-knob" transmitter tuning arrangements require extensive modification of electrical circuits, together with special mechanical arrangement of components. Here's a system which will work with any circuit arrangement you may choose — and which, furthermore, permits laying out parts for maximum electrical efficiency when the r.f. end is designed.

matically-tuned transmitters have been used in commercial fields for several years, but so far nothing has appeared that was within the financial reach or technical ability of the ordinary amateur.

The description that follows covers a system of automatic tuning and band switching which permits any transmitter to be shifted from one pre-set frequency to another and automatically tunes the entire rig "right on the nose," from oscillator to and including the antenna. A total of eleven pre-set frequencies can be used and they can be distributed among the various amateur bands in any way desired. When the system is used in connection with an E.C.O. it is possible to shift to any frequency in five bands almost instantaneously!

In designing a practical device to accomplish these results several requirements must be kept in mind. The device must be applicable to any type of transmitter, and must be capable of operating condensers, hand-switches, etc., which may be located in any position or place in the transmitter. Operation must take place without a multitude of extra parts such as pre-tuned tank circuits and relays, and the system preferably should require no electrical components that are not found in the average manually-tuned transmitter. Construction must be simple and installation easy, with adjustment and operation positive and foolproof. Finally, the device must be inexpensive.

The fundamental principle on which the device works is illustrated in Fig. 1. Pulley *A* is attached to the shaft of a variable condenser with the condenser movement controlled by flexible cable *B*. The cable is firmly attached, at one point, to the rim of the pulley. One end of the cable is held by tension spring *C* which tends to move the condenser toward full capacity. The other end of the cable is led over guide pulleys *D* and attached firmly to slider *E*.

A master cable *F* runs freely through a hole in the bottom of slider *E*; one end of the master cable runs over guide pulley *G* and is held under tension by spring *H*. The other end of the master cable runs across to guide pulley *I*, around it and back to pulley *J*, where it is firmly attached to the pulley rim. Pulley *J* is mounted on a shaft and controlled by lever *K*.

Mounted above the slider mechanism is a rotary "cage" assembly, composed of circular end plates and eleven threaded rods. A shaft runs through the center of the "cage" and the assembly is mounted in a position where it rotates above the slider mechanism. Movement of the rotary cage is accomplished by pulley *M*, drive cable *N*, guide pulleys *O*, and pulley *P*. Pulley *P* is mounted on a shaft and its movement controlled by lever *Q*. The movement of the rotary cage, which is actuated by lever *Q*, is made positive by the action of a detent mounted on the same shaft and behind pulley *P*. This device operates in the same manner as the detents used with ordinary rotary band switches; i.e., a ball bearing under spring pressure seats itself in a hole as each switch position is reached. Applied to the rotary cage, the detent permits easy rotation of the cage but clearly defines the "stop" position for each of the eleven threaded rods. This arrangement makes it possible to stop the cage in the exact position where the desired rod is directly above the slider mechanism. The eleven threaded "selector" rods are fitted with large knurled nuts *R*, which serve as stops.

When lever *K* is turned in a clockwise direction,

(Continued on page 85)

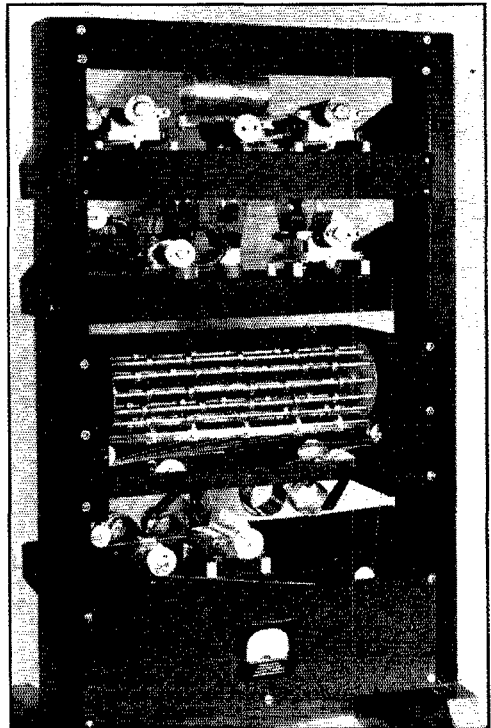

The control unit is designed to fit into a relay rack. Five circuits can be tuned automatically to eleven pre-determined frequencies which may be distributed as desired through the various bands.

Results, Fourth U.H.F. Contest and Relay

**Usual 56-Mc. May DX in Evidance — Arizona
Message Reaches Orlando, Florida**

By J. A. MOSKEY,* W1JMX

It was not without reward that our disciples of the ultra highs stuck to their guns throughout the May Contest/Relay. True to form, spring DX reared its sleepy head on both days to provide many of the gang with thrilling 500-1000-mile skip contacts, and to assist in making possible the longest relay yet accomplished in these affairs.

Outstanding, from the point of distance involved, was the route which connected Tucson, Arizona, with Orlando, Florida, an airline distance of 1800 miles! With a fortunate combination of favorable conditions making the feat possible, W6OVK, at 7:12 P.M. M.S.T., May 18th was able to despatch his test message to W5VV, Austin, Texas, 900 miles away. At 8:25 P.M. C.S.T., Wilmer, with Ole Man Skip still aiding the cause, passed it on to W9CLH at Elgin, Illinois, a further distance of 960 miles. The message was then relayed by means of ordinary lower-atmosphere contacts through W8CVQ, Kalamazoo, Michigan, to W8QDU at Detroit, who, taking advantage of another break in conditions, was able to pass it along to W4QN, Orlando, Florida, at 6:04 P.M. on the 19th. The total distance traversed by W6OVK's message was 3010 miles. Although this sort of relaying is not possible every day in the year, it is nevertheless true that a bit of thoughtful operating on the part of the fellows concerned went a long way toward the success of the Arizona-Florida circuit.

Originated in Winchester, Mass., at the start of the relay, W1HUV's test message also travelled to Orlando (1170 mi. airline) via W1HUV-W1GJZ-W1HDQ-W3AIR-W4ASE. The jump between W3AIR at Princeton, N. J., and W4ASE was made at 10:18 P.M. E.S.T. on the 18th while 56 Mc. was open for sky-wave work.

Much more reliable for regular traffic handling on the u.h.f. bands are the contacts over distances ordinarily workable under average conditions. Numerous networks employing short-haul relays, as usual handled the bulk of test messages. Listed below are those which were complete from originating station to the delivery point. (Asterisks indicate that a reply was received by originator.)

W1AKD/1-W1MDN-W1IUI/1-W1LNI/1; W1BDI/1-W1KIJ-W2AMJ-W3BZJ*; **W1CGY-W1HDQ-W1IZY-W1GJZ-W1BJE;** **W1DEI-W1HDF-W1KIJ-W2AMJ;** **W1GJZ-W1HDQ-W3AIR-W3BZJ-??-W3HWN-W8CIR;**

*Communications Department.

W1HPV-??-W1HDF-W1KIJ-W2AMJ*; **W1IUI/1-W1KIJ-W3BZJ*;** **W1JMT/1-??-W1JPM-W1EHT-W1JMT;** **W1KH-??-W1LPR-W1MDN-W1JK;** **W1LKG/1-W1MDN-W1DJ/1-W1JPM-W1GJZ-W1KIJ;** **W2HYJ-W2COT-W1KTF-W1HDQ;** **W2LRE-W2LJK/2-W3HOH-W3BZJ*;** **W2LUR-W2DKJ/2-W2HYJ-W2LKU/2*;** **W2MCG-W2HYJ-W2COT-W1KTF-W1HDQ*;** **W2MJJL-W2CWE-W2MCG;** **W3HOH-W2COT-W1KIJ-W1AZ*;** **W3AC/3-W3BKB-W8CIR-W8NYD-W8QDU-W8CVQ-W9GGH;** **W6MLA-W6SDI-W6QNU/6;** **W6QIN-W6QNU/6-W6QZA*;** **W6RUS/6-W6QNU/6-W6QZA;** **W6SDI-W6QNU/6-W6RVL;** **W6SET/6-W6KNE-W6QNU/6-W6IOJ-W6QZA;** **W6SQM-W6QNU/6-W6RVL;** **W8CIR-W3BKB-W3AC/3-W1KTF-W1HDQ;** **W8CIR/8-W3CGV-W3HDJ-W3AIR-W2AMJ-W1KTF-W1KIJ-W1BDI;** **W8CVQ-W8QDU-W8NYD-W8CIR-W8CIR/8-W3BKB-W3AC/3-W2AMJ*;** **W8NYD-W8CIR-W8CIR/8-W3BKB-W3AC/3-W1KTF-W1HDQ-W1BDI;** **W8QDU-W8NYD-W8CIR-W8CIR/8-W3BKB-W3AC/3-W1KTF-W1HDQ;** **W8QGS-W8QDU-W8NYD-W8CIR-W8CIR/8-W3BKB-W3AC/3-W1HDQ;** **W8UOS-??-W8RKE-W8CVQ-W8QDU-W8NYD-W8CIR-W8CIR/8-W3BKB-W3AIR-W2AMJ.**

The following tabulation shows how far we have been able to trace other messages which apparently did not reach the points to which directed.

Starting Station	Traced To	Starting Station	Traced To
W1CLH	W8CVQ	W2LLL	W2LXO
W1CUC	W3AWU	W2LOS	W2IQQ/3
W1EHT	W2COT	W2LRE	W3CGV
W1EKT	W2USA	W2LVQ	W2LXO
W1HDQ	W8CIR	W2MBB	W2MCG
W1IUI/1	W2COT	W2MEU	W8CIR
W1JJR	W3AWU	W2MUU/2	W2USA
W1KIJ	W8CIR	W2MWM	W3BKB
W1KTF	W8CVQ	W3AIR	W3AWU
W1LNI	W1FJN	W3BKB	W9ARN
W1LPR	W3AWU	W3BRZ	W9ARN
W1MDN	W3NF/3	W3CGV	W8CIR/8
W2MLM/1	W3NF/3	W3EEN	W8CIR/8
W2AFJ	W2LXO	W3FGV	W9ARN
W2AMJ	W1DEI	W3FIS	W3AC/3
W2COT	W3GGR	W3FJ	W3BKB
W2CPD	W3NF/3	W3GYG	W3HDJ
W2CTK	W2USA	W3HWN	W9ARN
W2CUZ	W1MDN	W3IKG	W3NF/3
W2CWE	W2LXO	W3IQN	W3BZR
W2DKJ/2	W2COT	W3NF/3	W3BZJ
W2DZA	W2COT	W3RL	W9ARN
W2GUC	W2COT	W3VX/3	W2USA
W2IBX	W2COT	W4ASE	W8CVQ
W2ILK/2	W8CIR	W5VV	W6OVK
W2ILO	W1JMT	W6EL	W6QZA
W2IZP	W3HPX	W6PQR	W6IOJ
W2JSL	W2CTK	W6PQY/6	W6QZA
W2KDV	W8CIR	W6BQJ	W6IOJ
W2KEM	W1KTF	W6KNF	W6LUR
W2KRE	W3CGV	W6MYL	W6IOJ
W2KTW	W3AC/3	W6QNU/6	W6MYL
W2LDV	W1LPR	W6QUK	W6DMQ
W2LKU	W2KDV	W6RVL	W6BQR



Operating from Oat Mountain, California (elevation 4000 ft.), W6QNU/6 scored 326 points to place third. 27 watts input to an RK34 long lines oscillator poked the 112 Mc. signal, in one instance, 146 miles to W6OIN in San Diego! The receiver was a 76-6C5 superregen and the antenna an extended double zapp. Power for the setup was furnished by a portable gas-driven 110 volt a. c. generator.

W7GSJ..... W7HSW
 W8KKD..... W8NKJ
 W8NYD..... W9UDO
 W8PKQ..... W1IZY
 W8QGZ..... W3BKB
 W8RFP..... W3BKB
 W8RKE..... W3BKB

W8TCX..... W8QDU
 W8TIU..... W8FJ
 W9ARN..... W8NYD
 W9IZQ..... W9GGH
 W9KZP..... W8NYD
 W9ZHB..... W8NYD

SCORES

Fourth U.H.F. Contest and Relay

(Figures represent score and number of different stations worked. Letters indicate band or bands used. A for 56, B for 112 and C for 224 Mc.)

W3AC/3.....384-34-A	W1DJ/1.....56-14-A
W2DKJ/2.....340-49-AB	W3RL.....54-10-A
W6QNU/6.....326-23-B	W1EHT.....50-23-A
W1KLL.....257-32-ABC	W1JJR.....47- 7-AC
W6KNF.....184-21-B	W8TIU.....47- 9-A
W6SET.....183-39-B	W1BDI/1.....44- 5-A
W8QDU.....180-20-AB	W1JVA/1.....44- 9-B
W1GJZ.....173-26-A	W3CGV.....42-18-A
W2COT.....170-38-A	W2DZA.....35-10-B
W1HDQ.....169-28-AB	W6OVK.....34- 3-A
W3HOH.....159-31-A	W1HUV.....33-15-A
W8BKB.....153-16-A	W9ARN.....33- 4-A
W2AMJ.....151-32-A	W2CTK.....32-11-B
WISS.....148-20-B	W3VX/3.....32- 5-A
W2MCG.....139-52-B	W6SDI.....28- 5-B
W2HEYJ.....102-40-AB	W7GSJ.....28- 2-B
W6RVL.....100-12-B	W9GGH.....28- 3-A
W1IUI/1.....94-14-A	W1CGY.....26- 5-A
W2ILK/2.....94-12-A	W1CUC.....25- 9-A
W3AIR.....94-20-A	W1LFP.....25-16-A
W8CVQ.....94- 8-A	W1CLH.....22- 7-A
W4ASE.....91- 8-A	W5EEX.....21- 1-A
W3HWN.....87- 8-A	W6QZA.....21- 1-B
W2LXO.....76-25-B	W3FIS.....17- 2-AB
W5VV.....73- 6-A	W3FJ.....15- 2-A
W1MDN.....72-21-A	W3IKG.....12- 1-B
W2AFJ.....71-24-B	W5HBO.....10- 1-A
W1EKT.....65-25-A	W3FBH..... 5- 1-A
W3NF/3.....62- 6-A	W1KIN..... 4- 2-B
W8QQS.....64- 9-A	W4ELZ..... 3- 3-A

The Survey of Headquarters

Off and on, ever since the League grew to respectable proportions, questions have kept coming up in the ranks of amateur radio and within the Board of Directors about the headquarters: whether it was really on the job, whether it was actually run with a high degree of business efficiency, whether the salaries paid were proper, etc. Lack of absolute knowledge on some of these questions was a constantly-disturbing irritation to the smooth course of League affairs. Last year the Board determined to answer these questions once and for all by means of a survey of the headquarters organization by a thoroughly competent firm of business engineers. To this end the Board appointed a special committee and gave them plenary powers to arrange for a thoroughgoing study and report. The committee was chaired by Mr. Bailey, the present president, and comprised Mr. McCargar from the Pacific Division; Mr. Reid, the Canadian General Manager; and Mr. Caveness of the Roanoke Division.

After a careful study of firms in this field, the Board selected the well-known establishment of Booz, Fry, Allen & Hamilton of Chicago to make the survey. They were to study the whole headquarters and particularly the business management of the League. Amongst other things, they were specifically instructed to find out whether

the headquarters gang were overworked or underworked, whether there were too many or too few people, whether they were overpaid or underpaid. The headquarters officers and staff were not "in" on the matter. The survey firm was hired by the Board, to report to the Board.

This past spring the surveyors moved into headquarters. For over three weeks they studied the work of the HQ gang, interviewed people, analyzed the method of handling all the steps in our multitudinous affairs, pried deeply into our files, studied all our books and records. About a month before this year's Board meeting, they issued their report, direct to the directors.

This is the Survey Report mentioned so frequently in the minutes of this year's meeting. What it tells about the League headquarters is a matter that must be of interest to every member. The Board of Directors wishes you to know about these findings, because it is your League. Every director has a copy of the report and will be glad to show it to interested members. But there is

(Continued on page 38)

This article has been written at the instructions of the A.R.R.L. Board of Directors, has been approved by the Board, and is published at the order of the Board — for your information.



ON THE ULTRA HIGHS



CONDUCTED BY E. P. TILTON,* W1HDQ

THOUGH skip DX may have occurred more frequently in the early part of the summer, it remained for July, as always, to produce that one *big night*. In 1938 it was July 22nd, the occasion of that record-breaking contact between W1EYM and W6DNS; in 1939 the big splurge came on the 27th. Every year, in late July, there seems to come a night when widespread ionization occurs in just the right places to permit multi-hop work over extreme distances on 56 Mc. Such a night was July 23, 1940, which, in the light of early reports, appears destined to take its place at the head of the list of memorable nights on Five. Certainly more DX work was accomplished, over more territory, than in any similar period in 56-Mc. history.

Hero of the evening, for the gang in the East, was Clyde Criswell, W6QLZ, of Phoenix, Ariz. Running 150 watts to an HK-54 feeding a 6-element quarter-wave-spaced horizontal beam, Clyde brought joy to the hearts of W1HDQ, W1DEI, W2GHV, W3's BZJ, HDJ and HWN, W8's CIR, RKE, QDU, QA and KQC; all over the 1500-mile mark. The contacts with your conductor and W1DEI are the first W1-W6 work on Five since that memorable W1EYM-W6DNS event mentioned above. The latter still stands as the recognized world's record, exceeding by at least 200 miles the distance between Massachusetts and Arizona.

Down in Dallas, Texas, W5AJG was having a time for himself also. Leroy felt certain that this was the night to get that long-awaited W7 and spent most of the evening, "one of the goriest openings I have ever seen," looking for some sign of signals from the Northwest. He was rewarded at 9:05 p.m. by a contact with W7FDJ,

*329 Central St., Springfield, Mass.

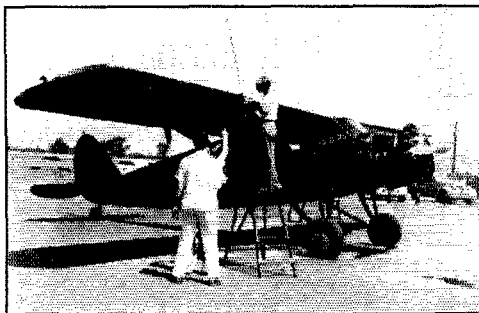

Gilbert de la Laing, W6BJL, mounts two half-waves in phase on the wing of the Stinson monoplane used in setting the 255-mile record for 112 Mc. on July 4th. Pilots Joe Bailey and Denny Whitney look on.

Houlton, Oregon. W5AJG thus becomes the station outside the Ninth Call Area to take them all, taking his place in the select class which now includes W9's ZJB, ZD, USI, and AHZ.

This opening was most remarkable, in practically every section of the country where five-meter stations are known to be operating in on the fun. A tip-off that some excitement might be expected shortly came on July 17th when, after nearly two weeks of nothing but minor openings, a vigorous opening occurred between W6 and W7. W6QG, Santa Ana, Calif., and W6QLZ and the boys in Tucson—W7's W1OVK, PGO and SLO—worked W7's W1I in Spokane, Wash., HEA, Zillea, Wash., D. Bothell, Wash., and FDJ, Houlton, Oregon, excellent signals each way. In the East, listed on Ten disclosed the fact that short skip was moving across the country, keeping step with the big low-pressure area which had developed along the West Coast around the 17th. Remember the big nights in late July in years past, the stations were primed for this one.

In the East we had the unusual spectacular strong inversion-bending appearing simultaneously with skip. Signals from W1, 2, 3 and 4, 5, 6, 7, 8, were extremely strong throughout the evening and the intermingling of these with the rapidly swinging sigs from W5, 6 and 9 made almost unbelievable turmoil in the territory between 56 and 58 Mc. W1, 2, 3, 5, 6, 8 and 9 were worked at W1HDQ, the W8 being supplied by W1KPN/8, operating with mobile equipment from Mt. Whiteface, near Lake Placid, N. York. W1DEI reported hearing all but W7, late in the evening W3HWN, Mechanicsburg, Pa., was heard to remark that he had heard them all.

QRM of serious proportions was experienced by many operators, a new experience for most of them on Five. W6QLZ says the band sounded "like Twenty, in the DX Contest," and W5AJG found the use of the crystal filter necessary most of the time. The opening started for W6QLZ at 4:30 p.m., with a contact with W9BJV, Watertown, S. Dak. W5AJG reports the band opened the morning, but the real "hot stuff" didn't start until about 5 p.m. Things started to happen in the East shortly after 6 p.m., indicating the break came almost simultaneously in most of the country. In the East it began to end with W5. In the early evening W5's W1ALK and AJG were pounding into W1, followed by the W9's, who appeared at about 7:30 p.m. and held the stage completely until about 8:30 p.m.

W6QLS appeared. Clyde was in for about an hour, along with the W9's whose sigs remained until around 10:45. The last activity heard was a series of contacts between various W2's and 3's and W5's EEL, ML and DXB, all of Louisiana, this lasting until nearly midnight. For the benefit of many who were unable to make the grade with W6QLZ, we present his "stations heard" list for July 23rd: W1KLLJ, S-4; W2's TP, S-9 plus, for 3 hours; MO, S-6; AMJ, S-5; W3HJQ, Sr8; W4's AUU, S-6; EDD, S-4; EQM, 5-6; W5's AJG, S-3; DXB, S-2; BYV, S-2; W6KTJ, S-9 plus; W8's PIL, S-6; BJG, S-2; RV, S-5; W9's VWU, S-2 (c.w.); AQQ, S-2 (c.w.); VHG, S-8; AZE, S-4.

HERE AND THERE:

W1ELP, Cambridge, Mass., is determined to prove that f.m. can do anything that a.m. can do and a lot more besides. To encourage tuning up to the high end of the band (58.5 Mc. and up), Bill is offering a log-book to any station contacted over a distance in excess of 150 miles from Cambridge. Skip contacts with W4's EQM, FBH and BBR; all with good reports, resulted when Bill called W1DEI on the headline while Mel was in contact with W4FBH, to ask him to get Roy to look above 58.5 Mc. W4BBR reported the f.m. signal as one of the strongest ever heard on Five.

Our flea-power friend, W1MEP, is getting out. During a period of exceptionally strong inversion-bending, on the evening of July 15th, we got W2AMJ to look for the signal which emanates from the fire tower on Glastonbury Mt. in Vermont. After some careful listening, Frank managed to find Chet's c.w. and contact was established; 150 miles over mountainous country on three watts! What band could do any better? Chet's location, 3764' elevation, may be the cause of much envy on the part of city dwellers (we've always nursed a secret desire to be a fire warden, too), but it has its drawbacks. You can't be a sissy, for one thing! Chet is a mere five miles from the nearest road, and as for the construction of a rig — well, how many of you would care to duplicate Chet's feat in completing an entire rig with only an alcohol torch for soldering? The batteries at W1MEP took a terrific beating on the 23rd but no skip contacts have yet been made. How about it, you long-eared gentlemen in W9? Keep careful watch on 57,486 for W1MEP! He's hearing you all.

You'll be hearing a lot of noise around 57,040 these nights. The big bass voice of W2MPA, Highlands, N. J., is now being heard regularly on Five, after a year of outstanding work on Ten. Ted was all tangled up in the job of getting on Five on the night of the 23rd but expects to make up for lost time, with 500 watts to a pair of TW-75's and a DM36-HQ120 combination.

One state we've heard but little from in recent times is Tennessee. As promised some issues back, W4BAF and W4GNN are on in Nashville. To date, the only contact made was with W1DEL, on June 24th. W1LLL was heard at the same time. Mac, W4BAF, wants it to be known that he operates on c.w. only. The rig is an 807 final at 50 watts. At W4GNN, an 813 runs 125 watts.

And speaking of rare states, we have no record of any stations being worked this year in any of the following: Idaho, Nevada, Utah, Wyoming, New Mexico, North Dakota, Arkansas, Mississippi, North Carolina and South Carolina. Is anyone active in these areas? There is no longer any such thing in the United States as an area, however remote, where 50-Mc. signals cannot be heard. Who will volunteer to pioneer in these undeveloped states?

Wilmer Allison, W5VV, now off the air until the conclusion of the tennis season, is not a fellow who does things halfway. A summary of the log at W5VV reveals an average of 7½ hours per day spent on Five between April 15th and July 4th! And with what result? Well, it appears that consistent effort turns the trick, for Wilmer had DX contacts



Aerial view of Mt. St. Helena, Mecca of many expeditions by the Santa Rosa gang. From this 1336-foot elevation, W6KIN/6 maintained contact with W6BJI 6 as the latter flew down the San Joaquin Valley to beyond Tulare, Calif.

during June on the 1st, 3rd, 4th, 9th, 13th, 16th, 17th, 19th, 20th, 27th and 30th, and July 2nd and 3rd, during which period 59 stations in 18 states and 6 call areas were worked. Not bad for a beginner!

Wilmer has been donating tubes and parts to operators in the area around Austin in the hope of providing consistent daily activity on Five during the winter months. Schedules will be started this fall with Houston, where W5EEX and W8ATW are working regularly and bearing down on the gang at Galveston to get the boys there started on Five. Houston and Austin are about 150 miles apart — a real test of efficiency. W5AJG and W5VV have heard each other over the 200 miles which separate Dallas from Austin. This is undoubtedly too great a distance to expect regular communication, but the boys hope to make it on a fair percentage of tries on schedule.

Over in West Texas we find W5EIN and W5HT in Big Lake, W5FNQ in Texon, and W5BYV in McCamey active regularly. With the assistance of a few more stations in the right places, these fellows would be all set to cover the nation's largest state in fine style.

While news from California is concerned mainly with big doings on 112 Mc., it appears that activity on Five is on the upgrade in the areas around Los Angeles and San Francisco. From Piedmont, Cal., W6VX reports the following stations active on schedule each Thursday night at 8 p.m.: AHH, DEK, LDP and CVP, San Francisco; KM (with both a.m. and f.m.), San Carlos; BPT, Santa Clara; KG, QLP and OHJ, San Jose; RPR, Oakland; and VX, Piedmont. And in the Los Angeles area, W6QG lists LFN, 50 watts, 57,400; CLH, 50 watts to 80L's, 58,616; PTJ, mobile; QG, 70 watts to an 808, 56,400; GAT, 35T doubler-final; RTZ and QKB, 6I, 6 finals; and IMJ, as among those heard regularly on Five. During the period of skip to W7 on the 17th, W6LEN observed that, in rotating his half-wave antenna from vertical to horizontal, the W7's came in best with the antenna tilted back 30 degrees from the vertical position.

W6KTY sends along a list of W7's worked by W6RZL, Huntington Park, on the 17th. In addition to W7's FLQ and FDJ, previously mentioned, RZL worked W7HEB, Free-water, Oregon, and W7HBW, Spokane. W7FDJ was knocking out a local, RZL reported.

Arizona-California contacts are being made this year on Five, we believe, for the first time. On July 2nd, W6QVK, Tucson, and W6QLZ, Phoenix, worked W6RPR in Oakland, for the first California contact on Five for both. The whole Tucson gang was in the shack when Jim worked W6RPR. "Boy! They scattered like quail when RPR showed up on my receiver," Jim relates, "but they didn't get home in time to connect with him." An unusual feature of this contact was the time of day, 3:25 p.m., a period in the day when skip DX is almost unknown.

On the 17th, W6QLZ heard W6QG during the time when the band was open to W7 for both parties. The distance

U.H.F. MARATHON

JUNE WINNER: W9ZJB, 636 POINTS!

Call	Contacts Through June			Cumulative Score	States in 1940
	56	112	224		
W1A1Y	19		3	63	2
W1BCT		3		6	2
W1CGY	7			20	3
W1CLH	68			240	12
W1CUC	24	5		38	2
W1EHT	48			65	2
W1EKT	79			216	9
W1ELP ¹	57	51		202	6
W1G1Z	118			435	12
W1HDF	56	11	4	269	13
W1HDQ ²	147	34		919	20
W1HXP	—	—	—	—	16
W1LJR	75		3	395	13
W1LJK	72			170	6
W1LJ	1	21		43	2
W1KLJ	188	7	5	1023	22
W1KVQ		68		146	1
W1LCC	13			16	2
W1LLL	102			591	18
W1LRF	54			112	6
W1LZV		84		176	2
W1MBS		80		162	1
W2ADW	13	12		90	3
W2AMJ	160			722	20
W2BYM	33			168	12
W2BZE	32	103		290	5
W2COT	94			183	7
W2CTK	23	57		151	5
W2DZA		41		96	3
W2GHV	91			400	17
W2LAI	68			172	10
W2LXO		103		254	4
W2MJL		16		32	1
W3AC	53			142	5
W3BYF	49			228	15
W3BZL	187	17		443	20
W3CGV	73			198	10
W3CYW	16			122	7
W3DI	92			464	15
W3EFS	22		1	73	3
W3FI	15			103	7
W2FSM		29		60	2
W3FX	37			99	3
W3HOH	197			587	15
W3RL	69			562	21
W4ELZ				94	7
W4FBH	67			597	17
W5AJG	114			1148	22
W5VV	54			662	18
W6IOJ	6	73		247	3
W6MKS		16		144	1
W6OVK	10			64	3
W6QG	20			77	4
W6QLZ	29	3		321	12
W6QNU		56		158	1
W6RVL		147		387	1
W6SLO	2			2	1
W6SNU	2			2	1
W6SNT	1			1	1
W8MHM	26	10	1	92	7
W8NKJ	42	20		239	0
W8PKJ	27			190	10
W8QDU	70	28		553	15
W8QSS	51			470	15
W8RUE	55	14		251	13
W8SNN	18			36	1
W8TIU	20			131	5
W9ARN	65			599	17
W9VWU	43			405	14
W9ZJB	101			949	24

To conserve space, calls of stations not reporting for two consecutive months have been deleted. These will be relisted upon receipt of additional reports.

¹ Frequency modulation used exclusively at W1ELP.
² Not eligible for award.

from Phoenix to Santa Ana, about 325 miles, and the rugged nature of the country in between, would seem to rule out the possibility of atmospheric bending making this possible. It looks as though this should be charged up as a sharp rebound from a tilted layer somewhere in the vicinity of the ionization which was causing the W6-W7 work.

Since we mentioned the fact that skip appeared to be getting longer, a few months back, we've received scores of reports of contacts being made and signals being heard over

paths of less than 500 miles. We have always assumed that 500 miles would be the absolute minimum distance over which E-layer contacts could be made. Our 25-point scoring in the Marathon for work between 250 and 500 miles was based on this assumption. Several of the boys, W9ZJB in particular, have been having some fun at our expense on this score. During June, Vince came up with W9AQQ, Indianapolis, 450 miles; W9ZQC, Brookings, S. Dak., 380 miles; and W9ZHB, Zearing, Ill., 350 miles. On July 27th, we heard Vince chortling over a 480-mile contact with Elkhart, Ind. We do not credit this sort of thing to a shortening of the skip in general, however, but rather to the vast improvement in rigs, receivers, and antennas; and to the wide-awakeness of the operators, to whom mere distance is not all. It remains a fact that the easiest contacts to make are those over distances beyond 800 miles. When a fellow knocks off one of those 25-pointers by means of sporadic-E skip he has earned his 25 points!

PITTSBURGH AREA FIVE-METER CONTEST

To stimulate daily activity on 56 Mc., the Pittsburgh Area Radio Club Council is sponsoring a contest during the month of September. The simple rules are listed below:

1. Any licensed amateur residing in the Western Pennsylvania Section of the Atlantic Division and the Counties of Brook, Ohio, Marshall, and Hancock of the State of West Virginia is eligible.
2. The period of the contest is from noon Sept. 1 to noon Sept. 30, 1940.
3. All contacts must be with licensed stations.
4. Scoring: A scoring period is from noon of one day to noon of the following day. One point will be allowed for each station worked on Five Meters during each scoring period. Stations worked more than once during a scoring period count as only one point for that period.
5. Total claimed score for the entire contest, together with a copy of the log, must be submitted to:
R. M. Francis, W3AVY, Secretary, P.A.R.C.C.,
 3577 Elmhurst St., Pittsburgh (12), Pa.

It is not necessary to file an entry. Stations may be operated fixed, portable, or mobile. Valuable prizes are promised to high-scoring stations.

112 MC.:

Here is the story on the latest 112-Mc. record, 255 miles, which was mentioned as a last-minute report in August QST. This record was no fortunate accident; rather, it was the result of the use of efficient equipment in a carefully-planned attempt to set a new world's record for 2½.

Albert C. Nuno, W6KIN, was set up on Mt. St. Helena, elevation 4336 feet, with an HK-24 oscillator, r.c. superhet, and a beam composed of four halfwaves in phase, with reflectors. Power was supplied by a 500-watt, 110-volt gas engine generator. At Santa Rosa Airport, Gilbert de la Laing, W6BJI, and pilots J. F. Bailey and Denman Whitney were at work from early morning, July 4th, until 11:30 a.m., when contact was established with W6KIN/6. The regular home rig of W6BJI, consisting of a 6V6GT triet with 7-Mc. xtal, 6V6GT doubler, 6L6GX doubler, and HK-24 doubler-final, was installed in the Stinson monoplane shown in the photograph on page 34. Power was derived from a

U.H.F. DX RECORDS

Two-Way Work

- 56 Mc.: W1EYM — W6DNS, July 22, 1938. 2500 miles.
 112 Mc.: W6BJI/6 — W6KIN/6, July 4th, 1940. 255 miles.
 224 Mc.: W1COO/1 — W1JK, July 13th, 1940. 90 miles.

vibrator supply operated from two storage batteries in parallel. The receiver was 6J5GT detector, 6N7 quenched oscillator-first audio, and 6V6 output, vibrator-powered.

Taking off at 11:40 a.m., they headed northeast to circle Mt. St. Helena. Maintaining continuous contact with W6KIN/6, the plane then headed southwest, following the great San Joaquin Valley to Visalia, where they landed for refueling. Back up again, shortly, to 5000 feet, S-9 two-way contact was reestablished with W6KIN/6, this ideal condition lasting up to 220 miles; when, near Fresno, signals started to drop rapidly. Climbing to a maximum of 9700 feet, contact was maintained until the plane was ten miles south of Tulare, a distance of 255 miles. Here the signal from W6KIN/6 was lost in the receiver noise in the plane, but flight was continued to see how long the plane rig could be heard at Mt. St. Helena. Turning back at about 20 miles south of Tulare because fuel was running low, contact was reestablished near Fresno; W6KIN/6 reporting that the signal had still been S-5 at the most distant point, 265 miles! From their experiences, KIN and BJI feel certain that 300 miles is possible on 112 Mc., and already plans are in the works for another record-breaker "as soon as competition warrants." Floyd Barnes, W6ADM; Galen Zumwalt; and Hjalmer Lundell, State Fire Warden at St. Helena, rendered valuable assistance in this record-breaking performance.

In the East, thrills for the gang in the metropolitan New York area have been supplied by W3BZJ, Glenside, Pa. Bob has one of the new Hallicrafter i.m. receivers, and has been using it to good advantage on 112 Mc. DX, at present is WILAS, East Portchester, Conn., well over 100 miles; and contacts with stations in New York City and vicinity are being made whenever the frequent summer temperature-

inversions permit. W2KYT, Franklin Square, L. I., reports that W3BZJ was worked every night from July 15th to 18th, with signals averaging S-6, reaching a peak of S-8 on the 15th. The distance to Glenside, a Philadelphia suburb, is 94 miles.

224 MC.:

AFTER having nothing to report of new activity on 1½, this band makes the headlines in July with a new world's record. Unless the boys in California take to 224 Mc., this one looks like it might stand for some considerable time. Working portable on July 13th from the summit of Mt. Washington, New England's highest peak, Arthur E. Bent, W1COO, made contact with Henry S. Shaw, W1JK, at Exeter, N. H., a distance of 90 miles. The rig used on Mt. Washington (elevation 6288 feet) was a pair of HK-24's using linear circuits in plate and filament. Shaw used a WE-316-A in a Peterson¹ oscillator. Both operators used National 1-10 receivers. W1COO reports that the use of copper-screen parabolic reflectors has resulted in worthwhile gain.

From the Nation's Capital, W3FQB reports W3EIS, Alexandria, Va., and 3WAWS, Washington, working regular on 1½. Rigs are as follows: W3FQB, HK-24's, t.n.t.; W3AWS, single KH-24; W3EIS, WE-316-A. Signals average S8 or better over the 8.5-mile path to Alexandria.

Interest in 224 Mc. in the area around Philadelphia is growing, with W3HDJ and W3DI firing up for work on this band. As soon as the peak of the 6-meter season passes, these fellows expect to go to work on 1½ in earnest.

¹ "High-Q Tank Circuits for Ultra-High Frequencies." Peterson, QST, July, 1939, p. 19.

U.H.F. Contest and Relay

September 14th-15th

The Contest Period: September 14th (Saturday), 3 P.M. local time, to September 15th (Sunday), 7:59 P.M. local time.

Scoring of Contacts: List all *different* stations worked in the contest period, and beside the calls show the *location* of the stations obtained as you work them for the claimed points. In a given band, a fixed or portable station may be worked but once for *contact credit* regardless of location. Contact points depend on the transmitter frequency of the station for which the claim is entered, and the distance covered, in line with the table below:

Distance of Station Worked	Number of Points Score, for Contacts Using Transmitter on		
	58-60 Mc.	112-116 Mc.	Above 224 Mc.
Under 25 miles	1	2	10
25 to 75 miles	2	4	20
75 to 275 miles	5	10	50
Over 250 miles	10	20	100

Scoring Message Credits: All contacts must be on frequencies assigned amateurs by the F.C.C. To the contact points computed as above may be added points for *message copies submitted, which show proper handling data* such as the station from which message was received, station to which the message was sent by radio, and the time and date of each such transfer of acknowledgments of receipt between stations. The call of the reporting amateur should of course be

indicated on each message, too.

For originating and sending a test message of approximately five to ten words, specifically addressed to remote sections of the country and submitting copy with handling data (but one such message per station may receive credit) — 10 points.

For relaying such messages away from the starting point toward destination and submitting full copies (1 for receiving by radio, 2 for relay onward) — 3 points.

Reply and 3rd party messages *relayed*, with copies submitted, also count as just explained, but for originating stations, but — 1 point.

Field Multiplier: Operators at field locations, under portable designation, may multiply the sum of their contact and relaying scores by *two*.

— * * * —

C.w. is recommended for accurate copy on the message, and to insure identification of your signal under difficulties at distant points. Scoring is the same for either 'phone or c.w. After you get your test message off, the aim is to work as many as possible, and push other test communications on their way in a responsible manner.

If you transmit in different u.h.f. bands, the same station may be worked *more than* once to count in the contact score. Fun and results are now assured, and informal week end work will

assure happy results for everybody. Special medallions are to be engraved at the end of 1940 for the fellows working most states. This is perhaps a rare operating chance to get some new states. Be sure we get your report, with claimed score and message copies, promptly after the September Contest-Relay.

We hope to see new gaps bridged, longer relay routes — and Marathon points and success and fun for everybody. The day is coming when a u.h.f. route will span the country! Everybody get on the air and hasten the day.

— F. E. H.

Got Your Code Proficiency Certificate?

THE new A.R.R.L. Award is available to every licensed ham who can do *something* above the license requirement itself! Look into this! You will find it good fun proving your ability — and you will get something to show for it. Full announcement of the WIAW practice transmissions and rules for submitting copy appeared in August *QST* (page 32). To put yourself in a position to win the highest possible certification of copy by ear aim to **WRITE DOWN** all you hear. The coordination of ear, brain and hand (make copy on a "mill" if possible) is what makes the difference between operators and those who merely hear the passing signals as they go by — the difference between useful operating in a communicating system and puttering at it. A little practice each day sending and receiving 3% to 5% above "perfect copy" speeds will add surprisingly to individual capabilities. Competence counts! In the A.R.R.L. program, two objectives will be (1) to get an A.R.R.L. certification of the highest transmitted speed that you can copy correctly as soon as possible, (2) to then practice definitely to improve that speed so you can win a further certification of **ADVANCED HONORS** by endorsement of that first award. **The next official test runs are scheduled at 10:15 p.m. EDST Friday, August 30th, and Saturday, September 21st, from WIAW. Start copy at 10:30!**

Oklahoma State Convention Oklahoma City, September 28th-29th

PLANS for the Oklahoma State Convention, scheduled for September 28th and 29th at the Biltmore Hotel, Oklahoma City, are shaping up nicely, according to Leroy C. Tyack, president of the sponsoring club. Plenty of excitement is planned for the ladies as well as the OM's, and the Oklahoma City Amateur Radio Club extends a cordial invitation to all amateurs to attend. Write OM Tyack, 2229 Northeast 27th St., Oklahoma City, for further information.

The Survey of Hq.

(Continued from page 33)

only one copy in each division and for that reason the Board has decided to print in *QST* the important parts of the report, for your information and so that you may know yourself what the surveying firm thought of the headquarters. Here they are:

Excerpts from the Report

This survey of the headquarters organization of the American Radio Relay League was undertaken at the request of the Board of Directors. The Board desired to have an unbiased opinion of the management and efficiency of the headquarters staff. In addition, they wished to know whether salaries are in line for comparable positions.

In conducting this survey we have interviewed each of the executive and supervisory employees of the organization. We have also talked with each clerical employee and observed the work performed. We have studied the functions of the organization and the methods by which those functions are accomplished. We have examined membership correspondence files and the records and accounts of the League.

Our findings show that the National Headquarters organization is generally well-manned and well managed. The personnel is of good quality. Positions are well filled and employees are giving satisfactory performances. Salary scales are in line with the salary ranges for similar positions in other organizations. Where there is a spread in these ranges, the League's salaries approach the minimum more often than the maximum.

As shown by results, the business management is satisfactory in most respects. Expenses are reasonable. With few exceptions,* methods are sound. Members are receiving services which cost more than double the price of membership.

To-day the American Radio Relay League is in a strong position. Its financial condition is sound. It is influential with the Federal Communications Commission. As the representative of the majority of radio amateurs in this country, and as the headquarters of the International Amateur Radio Union, it is the most influential organization in the field of amateur radio.

The supervisory employees of the American Radio Relay League have produced satisfactory results. The work of the headquarters organization has been described in Chapter II of this report. Those functions are satisfactorily performed. The League produces income sufficient to cover all expenses. Its operations are successful. It has grown in size and number of activities.

Our observation shows the rate of work to be satisfactory. In few spots, the correction of weaknesses* should increase efficiency slightly, but we see no place where a reduction in the clerical force is possible.

Our check of clerical salary scales showed that the compensation paid by the League was well within normal compensation for similar duties.

It was found that employees are producing results, that application and rate of work are satisfactory.

In contrast to these favorable conditions there are very few points of weakness. These weaknesses are not serious.

This organization compares very favorably with other non-profit organizations with which we are familiar in the calibre of personnel, interest and enthusiasm for the work and in service to the membership.

A few suggestions* have been made for the improvement of the organization. However, we feel that the members and Board of the American Radio Relay League can be assured that their headquarters staff has done and is doing an efficient, business-like and successful job for the organization.

* The few exceptions to the generally favorable report of HQ were all considered by the Board and were either directly acted upon, referred to the Finance Committee of directors, or directed to the Secretary for consideration.



CORRESPONDENCE FROM MEMBERS

The publishers of *QST* assume no responsibility for statements made herein by correspondents.

OPERATOR TRAINING

Felicity, Ohio

Editor, *QST*:

August *QST* has a very fine thought for the c.w. operators, and many of the 'phone operators (like myself) could stand some c.w. practice. But, please, let the 'phone operators improve their operating ability also. Mechanized equipment such as armored cars, tanks, airplanes, and artillery placements will all need 'phone operators. Some good, fast break-in practice with from two to ten stations in a round table, making short transmissions, would simulate the very thing that a company of tanks would need.

A c.w. operator in a tank that was traveling in an open field at thirty miles an hour could not send 30, 20 or even 10 w.p.m. so that the best of the c.w. operators could copy it. The same holds true for the small airplanes, especially on days when the air is plenty rough. . . .

The artillery placements should have equipment and operators for both 'phone and c.w.

Almost every coded message of the World War (1917) was decoded by the enemy, but although one company of the Signal Corps had their wires tapped while using telephone (voice) it wasn't decoded because there was a Cherokee Indian on each end using their native language. A word code is tougher to crack than a letter code, especially if the enemy speaks another language.

— Clyde M. Bartlow, *WSTPQ*

EDITOR'S NOTE.—Cleaning up 'phone transmissions generally and encouraging snappy, efficient, precise operating practice certainly should be encouraged. But lest amateurs whose primary interest is 'phone think they are thereby discharging their duty without equivalent concentration on building code speed, they should remember that trained voice operators can be secured by the military from many outside sources, trained code operators (by far the most vital and important) from only one — amateur radio. Help raise the average code speed of amateur radio by first raising your own. Then sharpen and tighten your operating practices, both 'phone and c.w.

B.C.L.'S INTERFERE, TOO

3316 N. Arsenal Ave., Indianapolis, Ind.

Editor, *QST*:

For the last few years I have been noticing a lot of heterodynes on the 160-meter band and the broadcast band.

After a little investigation, I found the trouble to be caused by broadcast superheterodyne receivers with no r.f. stage in front of the mixer. The oscillator, it seems, feeds into the antenna and does a right good job of getting out into the air.

This at times, no doubt, causes a headache or two for the broadcast listener, and I know for a matter of fact that on 160 signals were almost blocked out. What would happen in an emergency with a lot of low-power portables, I ask you?

The F.C.C. should, I believe, make radio set manufacturers install effective means of preventing this interference, regardless of the cost. (It should not cost much anyway.) . . .

— Wade C. Kingery, *W9JGZ*

LIGHTNING HAZARD

Old Forge, N. Y.

Editor, *QST*:

I was in a bad mood as I glanced through your last issue and read the portion relative to "Protection Against Dam-

age by Lightning." The suggestions given may have won awards but they will not stand much lightning direct or otherwise. "Good luck" is the answer.

Three hours before I read the article, and in spite of the fact that I had complied with the Fire Underwriters and had proper gaps and grounds, lightning made a direct hit on a spruce tree in which the far end of my 20-meter Zepp was attached, went by the gaps, came in the house, set fire to the wall on which was mounted the tuning net work, exploded the antenna meter (part of the works and glass are still in the back of my neck as I was just walking out of the room). My new steel rack and panel job which was well grounded is twisted and some of the parts melted but mostly ruined.

If I had been coming in the room I hate to think what would have happened, and if I had not been at hand to have put out the fire, part or possibly all the house would have burned.

There is but one safe way for protection, the way we used in the days of the "Marconi against ground": a 600-amp. switch that will take the lead-in from the set and put it to ground with a gap too great for another path at the rig. This will not win a prize but I am sure if you can find room for it in the book, it may serve to save equipment or a shack.

Incidentally, if you think your rig is covered by insurance, read your policy. A ham transmitter does not come under "Household and Personal Property" pertaining to the average household. Transmitters are not part of the average. Better have an indorsement put on your policy to include the rig, and even that won't cover the rig itself if struck by lightning unless fire ensues.

— Riley Parsons, *W8BXV*

PHILLIPS CODE

22604 W. McNichols, Detroit, Mich.

Editor, *QST*:

Why are more and more hams turning to 'phone operation? I believe one reason is that conversation can be carried on more rapidly by 'phone than by c.w.

There is a way, however, that the average code operator can speed up his QSO's without having to send his dashes and dots any faster. I refer to the use of Phillips code, or telegraphers' shorthand, which has been in daily use on land press wires since 1879 and has seen some radio usage.

Phillips code is a set of standard abbreviations, somewhat similar to the well-known "box-car code" used by railroad operators and some radio hams, but much shorter and completely standardized. It can be used to advantage in message handling by competent operators, but its greatest advantage has been for the fast handling of lengthy press dispatches, and carrying on lightning fast conversations in code. I have contacted a few old press operators on the ham bands, using Phillips, and talking to them is just like using 'phone. You can send much faster, with less effort, and the receiving operator is under no strain in receiving it. I have worked Fred McKay, *W6RJH*, through heavy QRM, at high speed, using Phillips, when a fast bug was unreadable. The code is suitable for either Continental or American Morse, and is sometimes used as shorthand for general newspaper and court reporting. . . . The standard code includes practically all of the common words used in newspaper English. From this it might appear hard to memorize, but the opposite is true. The system is so well designed that any person can learn it without much difficulty.

I should like to hear from hams desiring to use Phillips code, especially the ones who already know it. Perhaps we can make a sked.

— L. R. McDonald, *W8CW*

The 1.75-Mc. W.A.S. Party

BY E. L. BATTEY,* WIUE

THERE was a great to-do on the old 160-meter band throughout the February 17th-18th week-end, when the second A.R.R.L. 1.75-Mc. W.A.S. Party was under way. Participation was some 57% greater than in the first such activity, held one year earlier. The gang went at it with a vengeance and "160" received a work-out as never before! New records were plentiful, and a good time was had by all the 256 operators reporting results.

Stations were active in all 48 states. Logs were received from all states except Florida, No. Carolina, Utah and Wyoming. Leader in number of states worked was W9JYW with 41 (all but Arizona, Idaho, Maine, Mass., Nevada, R. I. and Utah). Forty states were worked at W9HHR, W4BPD and W9UWL. Those missed by W9HHR were Fla., Maine, Nev., Ore., Utah, Vermont, Wash. and Wyo. W4BPD got them all except Ariz., Idaho, Mont., Nev., Ore., Utah, Wash. and Wyo. W9UWL missed Ariz., Fla., Idaho, Nev., R. I., Utah, Vermont and Wash. W9YCF and W9WXL each worked 39 states. W3FDY, W9KOH, W5GYR, W4FLS and W5HXN each snagged 38.

W1BFT worked the most stations, 219, followed by W9HHR 208, W1TS 206, W8HGW 196, W4BPD 194, W3DQ 191, W3FDY 172, W1ZK 169, W6AM and W9KOH 166, W9ZBG 160 and W9OCF 151.

Special notice is due the leaders in each call area: W1BFT 6789 (W1TS 7004, non-competitive), W2KVE 3627, W3DQ 6685, W4BPD 7760, W5GYR 4636, W6AM 4316, W7GLX 2997, W8HGW 7056, W9HHR 8320.

Voice and code were both used intensively with splendid scores rolled up by each mode. However, the three highest scorers divided their time between code and voice. W9RBI and W9HHR

*Asst. Communicating Manager.

operating W9HHR led the country with the outstanding total of 8320 points (208 stations in 40 states). W4BPD placed second with 7760 points from 194 stations worked in 40 states. W8HGW was a good third with 7056, 196 stations, 36 states. Other highs in the group using both 'phone and c.w. were W1BFT 6789, W9KOH 6308, W9ZBG 5120, W1ZK 5070, W9OCF 4983, W9JID 4964, W1ATE 4526 and W6AM 4316.

Among those using voice only, W3DQ made the best showing with 191 stations in 35 states, a score of 6685. Second best voice-only scorer was W3FDY, who rolled up 6536 (172 stations, 38 states). Other high 'phone-only participants were W9JYW 5781, W5GYR 4636, W5FUA 4572, W1ERX 4257, W9YCF 4056 and W3HXV 4020.

Top scorer among those using c.w. only was W1TS, who worked 206 stations in 34 states, making a score of 7004 (non-competitive). Second highest code-only participant was W8DOD with 4495 points, 145 stations in 31 states. Other highs in the c.w.-only ranks were W3BTQ 3660, W3DGM 3640, W2KVE 3627, W9ENH 3300, W8LCN 2835, W8BYM 2727 and W3GDI 2580.

The Participants Say . . .

"The W.A.S. Party sure was FB. I am running only 8 watts input on 160-meter 'phone and it gave me a chance to see what the little peanut whistle would do." — W6NGK. "I have been on 160 c.w. for ten years and have never heard the band so well occupied. The band sounded like 40." — W3AJS. "My score is not much to brag about, but I sure had a lot of fun and that's what counts in a contest of this kind." — W2KON. "I could not help but be reminded of my operation years ago on the old 200 meter band, when I again worked such old timers as were on. The

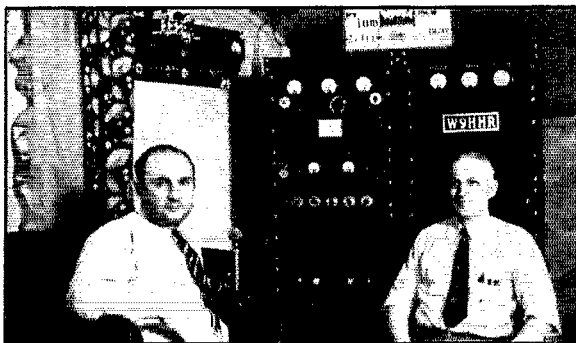

The Highest Scorers

Ross E. Hansch, W9RBI (left) and L. A. Russell, W9HHR, are pictured here at W9HHR, Wisconsin Dells, Wis., where they ran up the highest score in the party — 8320 (40 states, 208 stations). They used 500 watts on 'phone with crystal control, and a separate 100-watt c.w. transmitter with v.f.o. Antenna was a "160-meter Zepp," 60 feet high. Receivers used were Breting 14 and 81X.

W9JYW, Nebraska

W. A. Wessel, Jr., W9JYW, Nebraska City, Nebr., worked more states than any other participant — 41. His transmitter consists of Meissner Signal Shifter, TZ40 and P.P. T40's, running at 300 watts input and modulated by a pair of TZ40's. Antenna is a one-fourth-wave Marconi and counterpoise. Receiver used during the QSO Party was an HQ120.

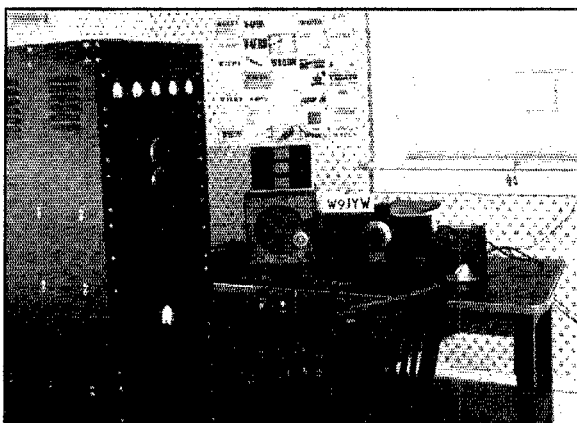

party waited for thirty minutes while W9KG and I talked over the old 200 meter QSO's we used to have, about sixteen years ago, at which time I was 9BIO." — W9AWP. "Got great kick working all districts on 160 c.w." — W3BTQ. "I am reporting two coast-to-coast contacts, one each with Virginia and New Jersey. All contacts were made with 85 watts input. Antenna used was a ¼ wave Marconi working against counterpoise." — W7GLX. "I have worked all States on 160-Meter 'phone, thanks to the W.A.S. Party." — W5FUA. "There seemed to be much more interest in the contest this year and everyone got into the spirit of it. Conditions were a little better than normal on the band." — W9KOH. "Both nights were good from coast-to-coast, and both c.w. and 'phone came through well. All districts were worked from here." — W6AM. "The QRM was a honey, but it really was a pleasure to hear so many signals on the 160 band, the most I've heard there since 1924." — W9AIR. "I worked all districts and made seven cross-country contacts, six W6, and one W7." — W8HGW. "We certainly enjoyed the contest; DX all over the band and enough stations on to QRM a band twice the size of 160. Unfortunately we were not equipped for c.w. operation and missed a few rare states on that account." — W5ISC. "I fully enjoyed the contest and it showed the possibilities of 160 that I didn't know before." — W2HAE. "I'm quite proud of working all districts the second night of the contest with the 30-watt rig and the short (even for 80) antenna." — W9ENH. "Coincidence: I worked W2HSP, and the next station was W8HSP." — W8QBR. "W3EQK made contact with W4EQK, both operating on the same frequency, 1888-kc. Also W3EQK and W3EUK were working on same frequency. Some fun!" — W3EQK. (Another coincidence: Note in the score list that W2DLK and W9DLK made same score! — E. L. B.) "The highlight for me was working W7GLX in Oregon ten minutes before the contest ended." —

W2MLM. "I certainly enjoyed this contest to the utmost." — W6PYH. "The contest provided more thrills than any other contest ever has provided." — W7HYI/W7UQ (ex-W9AHR).

And now for the scores . . .

Scores, 1.75-Mc. W.A.S. Party

(Stations are listed in order of scores. . . . Score, number of states and number of contacts indicated. . . . Stations whose calls appear in bold face type submitted the highest scores from their states)

W9HHR**	8320-40-208 ¹	W3GKR	3190-22-145 ⁴
W4BPD**	7760-40-194	W8QV**	3050-25-122
W8HGW**	7056-36-196	W7GLX	2997-27-111 ⁵
W1BFT**	6789-31-219	W8LCN*	2835-27-105
W3DQ	6685-35-191	W3EUK	2820-30-94
W3FDY	6536-35-172	W5HAT	2736-36-76
W9KOH**	6308-38-166	W8BYM*	2727-27-101
W9JYW	5781-41-141	W3CRW**	2646-21-126
W9ZBG**	5120-32-160	W3GDI*	2580-30-86
W1ZK**	5070-30-169	W9NQ1**	2575-25-103
W9OCF**	4983-33-151	W5HXN	2508-38-66
W9JID**	4964-34-146	W3HWB	2484-36-69
W5GYR	4636-38-122	W9GPO	2432-32-76
W5FUA	4572-36-127	W3HWL	2430-27-90
W1ATE**	4526-31-146	W9WKP**	2430-30-81
W8DOD*	4495-31-145	W9WJL	2378-29-82
W6AM**	4316-26-166	W3AZZ—	2373-21-113
W1ERX	4257-33-129	W9TDD	2340-36-65
W9UTL**	4148-34-122	W9ZK	2325-25-93 ⁶
W8JTH**	4060-28-145 ⁴	W9UWL	2280-40-57
W9YCF	4056-39-104	W9AWP*	2201-31-71
W6YX**	4031-29-139 ³	W2ASH*	2146-21-102
W3HXV	4020-30-134	W3FWP	2093-23-91 ⁷
W1ME**	3966-27-148	W9AVM**	2080-26-80
W9TKX**	3927-33-119	W9FCF	2000-25-80 ⁸
W4EV**	3910-34-115	W2KQ**	1940-20-97
W9WXL	3900-39-100	W2ISJ*	1932-23-84
W3BTQ*	3660-30-122	W5KC*	1924-26-74
W3DGM*	3640-28-130	W2JWK	1896-24-79
W2KVE*	3627-31-117	W8RUX**	1886-23-82
W2FXB	3600-30-120	W1RY*	1848-21-88
W4FLS	3534-38-93	W9CFB*	1846-26-71
W3CWG	3390-30-113	W9AU**	1800-24-75 ⁹
W1LCH**	3354-26-129	W1UW	1755-27-65
W9ENH*	3300-33-100	W3AWH*	1725-23-75

(Continued on page 88)

* Transmissions by c.w. only.

** Transmissions by both 'phone and c.w.

(Stations not marked by asterisks used 'phone only.)

¹ W9RBI and W9HHR ops. ² W8JTH and W8JIT ops. ³ W1DMV, W6QUU and W6HJT ops. ⁴ W3GKR and W3GIW ops. ⁵ W7GLX, W7FWC and W6OTQ ops. ⁶ W9ZK, W9FRO, W3YYZ, W3NKT and W9CJO ops. ⁷ W3FWF and W2EHI ops. ⁸ W9NBK opr. ⁹ Egyptian Radio Club, W9DJG and other ops. ¹⁰ W8NXX and W8CRM ops. ¹¹ W7HYI opr. ¹² W4GFK and W4BYN ops. ¹³ W8OCY and W8KLI ops. ¹⁴ W9SNR and W5ISC ops. ¹⁵ W5TYL and W8EPX ops. ¹⁶ W8HSH and W8BTQ ops. ¹⁷ W6BBE, W6ISG and W6TY ops. ¹⁸ W8QUM and W8TYM ops. ¹⁹ HQs stat members; not competing. ²⁰ W1JTD opr.



HINTS AND KINKS FOR THE EXPERIMENTER



TEMPERATURE COMPENSATION TO REDUCE RECEIVER DRIFT

STUART BRIGGS, WIKHE, and Claude Moore, W9HLF, two inveterate DX hounds, have been collaborating over the air for the past several months on some interesting work in temperature compensation to keep their receiver calibrations on the nose, come rain or shine. While the work of both has been with the National 101X, the same principles applied to other receivers should form a basis for similar compensation.

Without compensation, the drift would vary from 20 to 45 dial divisions, depending upon the temperature of the room when the receiver was turned on. All tests were made with the receiver "B" supply turned on one minute after the voltage was applied to the heaters.

They started out the tests by connecting a Centralab 10- μ fd. negative-coefficient condenser (type 913N) from ground to the grid leak of the high-frequency oscillator, placing the condenser very close to the top of the 6J7. To compensate for the added capacity, the capacity of the air trimmer in the h.f.o. coil compartment was reduced correspondingly. Using a temperature-controlled oscillator for checking the drift, it was found that the receivers ran off calibration by two or three dial divisions at the beginning of a cold start. Within 5 to 8 minutes, the calibration would return to the original and would remain there within a dial division or so over periods of several hours.

Next, the mixer and r.f. circuits were given the same treatment. The improvement in stability was immediately evident. The compensating action was speeded up and, from a cold start, the calibration would deviate only about one and one-half dial divisions and return on the nose within three minutes. The more accurate maintenance of circuit alignment resulted in a noticeable improvement in the gain of the receiver.

More recently, W9HLF replaced the metal tubes in the h.f. circuits with a set of three of the Hytron GTX series. Some slight changes were necessary to suspend the compensating condensers over the glass tubes which are taller than the metal envelopes. This change resulted in an improvement in receiver sensitivity. WIKHE, following suit, experienced a similar improvement. With the new tubes, it was found that it was necessary to readjust the compensation. By

reducing the compensating capacity in each case from 10 μ fd. to 5 μ fd., the compensation was brought back into line. Since condensers with capacities of less than 10 μ fd. were unavailable, two 10- μ fd. units were connected in series.

By this time, both operators had become supercritical in the matter of frequency drift. In observations over long periods of operation, they noticed a slow drift upward in frequency which occurred after a run of ten to twelve hours. Although the drift was at the rate of only a dial division per hour, they decided to eliminate it, if possible. After a lengthy investigation, it was determined that this secondary drift was caused by a lagging rise in temperature in the coil chamber. To compensate for this, a negative coefficient condenser of approximately 7 μ fd. (25 μ fd. and 10 μ fd. in series) was connected directly across the air trimmer in the coil compartment with the condenser mounted right against the coil with a drop of Duco cement. This completed the job.

W9HLF says that he has run his receiver for as long as 4 and 5 days at a stretch without having the calibration vary more than one dial division at any time. During 24 hours, the temperature might have varied from 40 to 100 degrees. "I've become so used to being able to spot a certain signal, day in and day out, at the same zero-beat point on the dial, and, after five minutes of warm-up always finding my 100-kc. frequency-meter signal spotted at the same old dial division of the 101X that I take it all for granted now and only when I get hold of some other fellow's receiver do I notice how unstable the best of them may be."

While most of this work has been done at 14 Mc., WIKHE has had similar success at the lower frequencies.

REPLACING AN 83 WITH 866 JR.'S FOR HIGHER VOLTAGES

EVERY once in a while, we hear from hams who have been a little too optimistic in judging the voltage which an 83 rectifier will take. As a result they find that frequent replacement is necessary. However, it's a lot cheaper to get rid of the trouble permanently by replacing the 83 with a pair of 866 jr.'s. This can be done quite simply in most cases, since the filaments of the 866 jr.'s operate at 2.5 volts, 2.5 amperes, while the 83 operates at 5 volts, 3 amperes. Therefore,

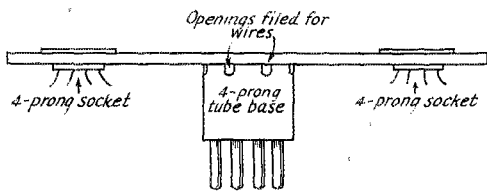

Fig. 1—Adapter for replacing type 83 rectifier with type 866 jr.'s for higher voltages. If the rectifier filament transformer has no center tap, make positive high-voltage connection at center of series-connected filaments. The strip is fastened to the tube base by a 6-32 screw running through the center of the tube base.

it is necessary only to wire the filaments of the 866 jr.'s in series to operate from the same filament transformer.

If a 4-prong tube base is available, an adapter may be made up in a few minutes as shown in Fig. 1. The shape of the mounting strip and the location of the adapter plug may be varied to suit the available space.

KEYING-MONITOR SYSTEM

HAVING rejected most forms of monitoring arrangements requiring extra relays, power supplies, etc., I finally arrived at the one shown in Fig. 2 which seems to fill the bill perfectly here

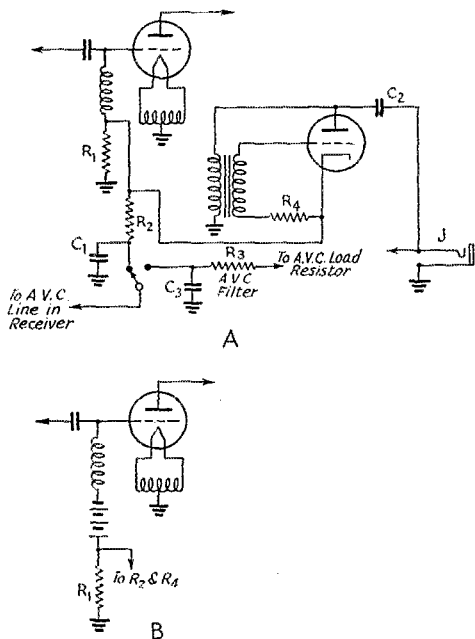

Fig. 2—Break-in keying-monitor system with automatic receiver blocking. R_1 is the usual grid-leak resistance recommended for the stage in use. R_2 is a 0.1 meg. 1-watt resistor. A capacity of 0.25 $\mu\text{fd.}$ is recommended for C_2 , although this capacity may be varied for a change in delay. C_3 is 0.01 $\mu\text{fd.}$ C_3 and R_3 form the usual a.v.c. filter in the receiver.

at W2GXW. As shown in the diagram, a simple triode audio oscillator feeds the monitoring signal into the headphones of the receiver through a 0.01- $\mu\text{fd.}$ coupling condenser, C_2 . J is the regular receiver headphone jack with the connection made to the ungrounded side.

Plate voltage for the audio oscillator is taken from the d.c. voltage drop across the grid leak (R_1) of one of the transmitter stages. Thus, the oscillator is keyed automatically with the transmitter. In my case, this stage is one in which an 809 is used where the biasing voltage developed across the grid leak is of the order of 75 to 100 volts. The scheme should work satisfactorily with any stage whose operating grid voltage does not exceed the plate-voltage rating of the audio oscillator tube. In cases where the operating bias voltage is higher, the grid leak could be tapped at a point which will give the right voltage. If a fixed biasing voltage is required for plate-current cut-off, it will be necessary to introduce it between the grid leak and r.f. choke as shown in Fig. 2B to prevent continuous operation of the audio oscillator.

The biasing voltage is also applied to the grid returns of the r.f. stages of the receiver through R_2 , effectively cutting these stages off whenever the key is closed. R_3 and C_3 form the usual a.v.c. filter in the receiver. The usual grounding switch which cuts out the a.v.c. is replaced with a s.p.d.t. switch so that the monitoring system may operate with the a.v.c. system off and that the monitoring system will not interfere with the a.v.c. system when it is in use. C_1 provides time delay which may be adjusted by a change in its capacity.

The circuit has no effect upon the operation of the transmitter since the current consumed by the audio oscillator is less than 0.25 ma.

— J. F. Masterson, W2GXW

SURE-FIRE AUDIO OSCILLATOR

SEVERAL years ago, after many unsuccessful attempts to make any of the various audio oscillator hookups work satisfactorily, I finally gave up the whole idea of making one myself. Inquiries among my friends showed that they were having a lot of trouble with the regular hookups of audio oscillators and usually they ended up by buying a commercial job.

Recently the urge to own a good audio oscillator came up again, and having plenty of old parts around the shack I made up my mind that I would keep working at it until it would operate correctly.

The diagram of Fig. 3 is the result, and it certainly is a sweet outfit considering the few parts needed. The audio tone can be varied over a considerable range; it can be adjusted to feed into any reasonable impedance load; the power output is high enough for any practical purpose; and, best of all, it is not a bit critical in regard to

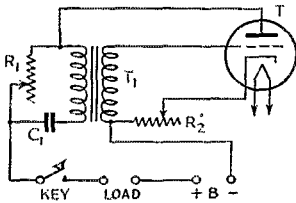

Fig. 3 — Circuit of sure-fire audio oscillator.

- T — 6C5 tube (Probably any triode will work OK).
 T₁ — Audio transformer.
 R₁ — Variable resistor (Old Bradleyohm was used here. Resonance was obtained at about 4200 ohms).
 R₂ — Variable resistor that will cover 0-10,000 ohms or more. (Preferably with fine adjustment such as on Bradleyohm, in order to pick the correct note easily.)
 C₁ — 0.01- μ fd. paper condenser.

filament or plate voltage. The 6C5 tube will operate with less than 3 volts on the heater and I have varied the plate voltage from 200 down to 45 volts without any trouble with oscillations stopping. The 45-volt tap was the lowest voltage tap that was available here at the time, but I believe that it would have continued working at very much lower voltages than that.

The best feature of this hookup is the ability to change the tone pitch to any desirable note. This feature is particularly handy for i.c.w. work on the ultra-high frequencies since the note can be varied to just the correct pitch to cut through auto interference.

Just a word about adjusting the outfit. You will find that both resistors will have to be varied at first to get the rig working, but a setting of R₁ will be found (in my case it was about 4200 ohms) where the resistance may be left alone and all changes in pitch will be obtained by varying R₂ in the cathode circuit. Any changes in load impedance or voltage on the tube may make it necessary to change both resistors again, but I have yet to find an impedance that will stop it oscillating.

I hope this will help out some of the boys who have had their troubles trying to get an oscillator working. — Gordon V. N. Wiley, W1AUN.

WWV Schedules

EXCEPT for the special broadcasts of WWV using 20 kw. as described below, WWV is now running a continuous schedule (day and night) on 5000 kc. with a power output of 1 kw. This continuous transmission is modulated with the standard pitch in music, 440 cycles per second.

Each Tuesday, Wednesday and Friday (except legal holidays), the National Bureau of Standards station, WWV, transmits with a power of 20 kw. on three carrier frequencies as follows: 10:00 to 11:30 A.M., E.S.T., on 5000 kc.; noon to 1:30 P.M., E.S.T., on 10,000 kc.; 2:00 to 3:30 P.M., E.S.T., on 15,000 kc. The Tuesday and Friday transmissions are unmodulated c.w. except for

1-second standard-time intervals consisting of short pulses with 1000-cycle modulation. On the Wednesday transmissions, the carrier is modulated 30% with a standard audio frequency of 1000 c.p.s. The accuracy of the frequencies of the WWV transmissions is better than 1 part in 10,000,000.

★ A.R.R.L. QSL BUREAU ★

FOR the convenience of its members, the League maintains a QSL-card forwarding system which operates through volunteer "District QSL Managers" in each of the nine United States and five Canadian districts. In order to secure such foreign cards as may be received for you, send your district manager a standard No. 10 stamped envelope (standard business size, 9 $\frac{1}{2}$ " x 4 $\frac{1}{8}$ "). If you have reason to expect a considerable number of cards, put on an extra stamp so that it has a total of six cents postage. Your own name and address go in the customary place on the face, and your station call should be printed prominently in the upper left-hand corner.

- W1 — J. T. Steiger, W1BGY, 35 Call Street, Willimansett, Mass.
 W2 — H. W. Yahnel, W2SN, Lake Ave., Helmetta, N. J.
 W3 — Maurice Downs, W3WU, 1311 Sheridan St., N. W., Washington, D. C.
 W4 — G. W. Hoke, W4DYB, 328 Mell Ave., N. E., Atlanta, Ga.
 W5 — James F. Manship, W5ALE, 910 So Boston, Tulsa, Okla.
 W6 — Horace Greer, W6TI, 414 Fairmount Ave., Oakland, Calif.
 W7 — Frank E. Pratt, W7DXZ, 5023 So. Ferry St., Tacoma, Wash.
 W8 — F. W. Allen, W8GER, 450 Fountain Ave., Dayton, Ohio.
 W9 — Alva A. Smith, W9DMA, 238 East Main St., Caledonia, Minn.
 VE1 — L. J. Fader, VE1FQ, 125 Henry St. Halifax, N. S.
 VE2 — C. W. Skarstedt, VE2DR, 236 Elm Ave., Westmount, P. Q.
 VE3 — Bert Knowles, VE3QB, Lanark, Ont.
 VE4 — George Behrends, VE4RO, 186 Oakdean Blvd., St. James, Winnipeg, Manitoba.
 VE5 — H. R. Hough, VE5HR, 1785 First St., Victoria, B. C.
 K4 — F. McCown, K4RJ, Family Court 7, San-turce, Puerto Rico.
 K6 — James F. Pa, K6LBH, 1416D Lunalilo St., Honolulu, T. H.
 K7 — Jerry McKinley, K7GSC, Box 1533, Juneau, Alaska.
 KA — George L. Rickard, KA1GR, P. O. Box 849, Manila, P. I.



OPERATING NEWS



F. E. HANDY, WIBDI, Communications Mgr.

E. L. BATTEY, W1UE, Asst. Communications Mgr.

September's Invitation. Fall weather is coming. Cool nights. Little or no static. Swell sigs. The new operating season is on! It will be a big year in ham activity, perhaps the best ever. The bands sound intriguing . . . fellows to talk to far and near . . . new communication opportunities. All the usual special League activities are planned, with the possible exception of a DX contest. Most of us are happy without that in the knowledge that Order. No. 72 adds to our security in the pursuit of our hobby of self-training and public service. When we stop to consider it we discover that about all that a foreign amateur ever could do classified as DX, but our amateur field has been much broader. We have *all sorts of interests*: traffic nets, field days, copying bees, quarterly ORS and OPS activities, sweepstakes and other contests, awards for working all states, rag chewing, frequency measurement, appointments for signal checking (Official Observer), 'phone operating which subscribes to high standards (Official 'Phone Station), traffic operating (Official Relay Station).

A.R.R.L. Field Organization interest may be expected to be greater than ever this fall. There are Trunk Line posts to be filled from those with O.R.S. experience who are on the waiting list. The Section Managers elected by the members make all the appointments. Information on the different posts will be sent to any League member who asks for specific information, so he may then get in touch with the S.C.M.

Section Net memberships should reach new highs this year. The posts of Route Manager and Phone Activities Manager take fellows with good stations and organizing initiative, to arrange nets and activities, and S.C.M.s are constantly on the alert to find operators with the time, interest, and ability to assume such leadership for A.A.R.L. c.w. and 'phone networks. To get into one of these groups brings the real experience of radio fraternalism, coupled with a wealth of constructive fun and operating practice.

Emergency Communication is a field in which *every licensee* should be enlisted, and the League policy in this field is by no means confined to those who are members. Every amateur operator is urged to register his equipment with the Emergency Corps, and get lined up for possible public service. *Do it right away.* (Get registration blanks from the nearest A.R.R.L. official, or your local Western Union office. We have an A.E.C. membership card and information for all who register.) Early in 1941 we hope to announce a special new

radio activity in collaboration with the American Red Cross. This will be of special interest to the A.R.R.L. Emergency Corps.

Emergency Coördinators are needed, a thousand more of them. This is a respected post for mature amateurs with organizing ability. The amateur service not only must advance Emergency Corps registrations and local planning for any communication contingency, but a Coördinator to serve each community where there is a Red Cross Chapter, to speak to all agencies on behalf of the radio amateur group organization for that locality is needed wherever such post is not already filled. Recommendations for these posts are earnestly solicited, to aid S.C.M.s in this expansion of our organization. Applications for all League appointments and awards are expected to be plentiful this fall. Line up those ORS/OPS posts early then, for maximum operating opportunity in the new radio season.

Code Proficiency Certificates. Next Runs Aug. 30th and Sept. 21st. Last month the first WIAW transmissions designed to help you qualify for a Code Proficiency Certificate were announced. Daily-except-Friday, WIAW sends a schedule of practice. At this writing we are lining up other stations with tape transmitters so we can have more practice available. Between the amateur bands numerous government and commercial, press and weather transmissions by tape are going on at a variety of speeds. These will help you correlate hand and mind in writing down accurately, the code that you wish to copy. Listen daily-except-Friday to the practice period from WIAW. The speeds are progressively increased between 15 and 35 w.p.m. inclusive, between 10:15 P.M. and 10:35 P.M. E.D.S.T.

<i>WIAW Frequencies (simultaneous)</i>	<i>Starting Time</i>
1761-3825-7280-14,254-28,600 kcs.	10:15 P.M. EDST, or
	9:15 P.M. EST, 8:15 P.M. CST,
	7:15 P.M. MST, 6:15 P.M. PST.

Proficiency Certificate Award runs from WIAW (instead of practice) will take place (QST at 10.15 DST, copy at 10.30) August 30th, and again on September 21st. Copy down what you hear at the highest speed you can take solid. Attach a statement certifying over your signature that it is direct copy, by ear, without personal or mechanical aids. Note if the copy was by hand or on a typewriter. Mail us the original copy for greatest chance of qualifying. If you have acquired a Code Proficiency Certificate, and are working for a Silver Endorsement Sticker for higher speeds, please so state in submitting your copy.

The value of traffic handling as a builder of code ability, particularly the ability to copy accurately and put handling data on the communications handled, is widely recognized. We suggest that every amateur try to participate in the organized A.R.R.L. Section Nets as soon as proficiency in the fundamentals makes this possible. S.C.M.s have special Section Net Certificates for recognition within these groups of key stations that endeavor to cover each part of A.R.R.L. territory. It will be a big year in amateur radio. You can win a Proficiency Award, or qualify for an A.R.R.L. appointment if you

haven't done so and will exert the necessary effort. We suggest that you check your personal proficiency in the regular practice runs; aim to qualify for a Certificate, and then an endorsement on top of that. Aim at the traffic branch of radio enjoyment to increase proficiency, and to satisfy your friends and radio acquaintances how amateur radio communication works. September starts the new season. Let us make it a season of individual proficiency and real accomplishment in the things that count for something.

—F. E. H

Code Proficiency Also Means . . .

Good Sending by Correct Bug Adjustment

TIME and again we have heard abuse heaped on the "splatterbug" . . . but no one has given hints on remedying the faulty nerve coordination behind misuse of a bug . . . except to suggest HEAVIER WEIGHTS and MOVING FINGER TIPS, OUT which of course IS the first fundamental. All credit to Dixie Jones, W4IR, for the progress made by focusing attention on the evils of sloppy bug sending, RHYTHMIC SPACING and correct sending of characters is essential for accuracy. How we all admire the operator who can use a bug key correctly, and send the extra dots on his B's and F's in his H's every time. All of us who use bugs know how disconcerting it is to have to make estimates and allowances for the yards of superfluous dots thrown at us by the greenhorn or the guy trying to make an impression in his use of the "animule." Many of us properly shaken and ashamed when we affix some extra dots unintentionally to characters — extremely difficult to prevent when we sit in on a circuit with some bug that has an unfamiliar adjustment. With the correctly adjusted bug some still have trouble. So we are pleased to quote from a contribution in the *Yankee* by W1CFO, and hope you find the ideas helpful, which we have been looking for just such ideas:

"All of us tend to develop poor practices with bug keying. The beginner must get started right, or his fist will not be pleasant reading. The old timer must forever get himself out of disagreeable habits acquired while hammering away, sometimes without realizing it.

"One of the most common errors of bug keying is the throwing in of superfluous dots, free gratis. This makes interesting sounds (b) but does not make for accuracy.

"The worst offense is the running together of common words, such as sending PD for 'and' and 6E for 'the,' to say nothing of numerous other combinations. On top of all this is the choppy style, the slurry style, or the drag, then the one so common to bug key users, the kind that I call the 'Backhand Rhythm.'

"To correct the practice of running together, and that of sending extra dots, is simple enough, and can be done with the same kind of practice. First, get a newspaper, or something to read from, and practise sending backwards. Take a sentence, send it backwards about ten times, then send it once in the proper manner.

"For the second exercise, set your key for a speed of about forty words per minute. Now start sending straight text, and after each letter, take your hand away from your key entirely. If you can't think of anything to do with your hand, scratch your ear with it, or anything else that comes handy. Practise this way for ten minutes and then send the same text over in the normal way. After a few days at this sort of practice, I'll guarantee you will send some readable code, with spacing in it!

"For eliminating superfluous dots, there is nothing like this practice of taking the hand away from the key after each letter. While practising this, change the dot speed weight to several different speeds until you can send any dot combination with any given speed and the right number of dots.

"Everyone develops some kind of a swing in sending. Some of these swings are hard to read and others are easy. The perfect swing to read goes like the sending of a good operator with a straight key. Listen to some good commercial sending, and you will get the idea of a swing that is worth while trying to imitate." — By W1CFO, from the September *Yankee*, 1st Corp. Area, A.A.R.S.

Field Day Scores

THE following are high claimed scores reported at the A.R.R.L. Field Day, June 22nd-23rd. These are subject to cross-checking and grouping by number of multaneously operated transmitters used at each station. Complete F.D. results will be presented in a later issue.

Frankford Radio Club	W3BKX/3	84
Jersey Shore Amateur Radio Association	W2AER/2	82
Tri-County Radio Association, Inc.	W2GW/3	81
St. Paul Radio Club	W9KYC/9	68
Egyptian Radio Club	W9AIU/9	68
Bridgeport Amateur Radio Association	W1JHT/1	61
Beacon Radio Amateurs	W3ATR/3	56
Delaware Valley Radio Association	W3AQ/3	54
Tri-States Radio Club	W3GKI/2	54
Cuyahoga Radio Association	W8URA/8	50
Dells Region Radio Club	W9RBI/9	50
Radio Operators Ass'n of New Bedford	W1UJ/1	46
Philadelphia Wireless Association	W3GAG/3	48
Mountaineer Amateur Radio Association	W8BOK/8	48
New Haven Amateur Radio Association	W1GB/1	47
York Road Radio Club	W3QV/3	47
Northern Nassau Wireless Association	W2WQ/2	46
Buckeye Radio Club	W8ODJ/8	44
York Radio Club	W9KA/9	43
Society of Amateur Radio Operators, Inc.	W6VX/6	43
Palomar Radio Club	W6RZZ/6	41
Schenectady Amateur Radio Association	W2ACB/2	40
Illinois Ham Club, W9MD/9, 3932; So. Hills Br Pounders & Modulators, W8UK/8, 3807; Chester Ra Club, W3DRQ/3, 3798; Suffolk Amateur Radio Cl W2AVS/2, 3771; Amateur Transmitters Ass'n of W. Penn W8CUG/8, 3612; Sheboygan Radio Amateurs Cl W9UJM/9, 3582; San Francisco Radio Amateur Em gency Corps, W6CIS/6, 3519; Cahokia Amateur Ra Club, W9TCK/9, 3492; Prairie Dog Emergency C W9JU/9, 3474; Non-club, 5 oprs., W3GGC/3, 3438; No		

Newark Amateur Radio Club, W2PY/2, 3411; Merrimack Valley Amateur Radio Ass'n, W1DMD/1, 3366; Northwest Amateur Radio Club, W9LIP/9, 3345; Motor City Radio Club, W8MRM/8, 3339; Central Illinois Amateur Radio Club, W9UQT/9, 3312; Greater Cincinnati Amateur Radio Ass'n, W8NC/8, 3177; K.B.T. Radio Club, W8NWH/8, 3132; Non-club, 23 oprs., W9V8X/9, 3114; Trenton Radio Society, W3AIR/3, 3033; So. Cleveland Radio Club, W8CMB/8, 3033; Manchester Radio Club, W1DJC/1, 2916; Norfolk Radio Club, W3BEK/3, 2907; Warren County Radio Club, W8SVT/8, 2907; Queens Radio Amateur Club, W2CWE/2, 2835; Non-club, 3 oprs., W8QOK/8, 2831; Louisiana Tech Radio Club and Red River Radio Club, W5AXD/5, 2808; Valley Key and Mike Club (Sharon, Pa.), W8OAJ/8, 2745; Non-club, 6 oprs., W2IYQ/3, 2727.

W1AW Operating Schedule

All times are given as E.D.S.T. The schedules at the stated times effective Sept. 1, 1940, change to E.S.T. effective from Sept. 29, 1940.

OPERATING-VISITING HOURS:

3:00 P.M.-3:00 A.M. E.D.S.T. daily, except Saturday-Sunday.

Saturday — 8:30 P.M.-2:30 A.M. E.D.S.T.

Sunday — 7:00 P.M.-1:00 A.M. E.D.S.T.

OFFICIAL BROADCAST SCHEDULE (for sending addressed information to all radio amateurs).

Frequencies

C.W.: 1761-3825-7280-14,254-28,600 kcs. (simultaneously)

Starting Times (P.M.)		Speeds (W.P.M.)								
EDST	CDST	MDST	PDST	M	T	W	Th	F	Sat	Sun
8:30	7:30	6:30	5:30	20	15	25	15	20	—	20
Midnight	11:00	10:00	9:00	15	25	15	20	15	15	—

PHONE: 1806, 3950.5, 14,227, 28,600 kcs.

Each code transmission will be followed in turn by voice transmission on each of the above frequencies.

CODE PRACTICE:

Besides the O.B.S. times and word speeds given above, W1AW will adhere to a schedule for sending code practice transmissions at progressively increasing speeds (15 to 35 w.p.m. in 5 w.p.m. steps) daily except Friday, starting at 10.15 P.M. E.D.S.T. Proficiency Certificate Award qualifying runs start 15 minutes later than practice schedules on a date announced for each month. (Next one's on Aug. 30th and Sept. 21st.)

GENERAL OPERATION:

Besides specific schedules in different bands, W1AW devotes the following periods, except Saturdays and Sundays, to GENERAL work in the following bands:

Time, E.D.S.T.	Frequency
4:30 P.M.- 5:00 P.M.	28,600 kc. Fone/CW
6:00 P.M.- 6:30 P.M.	14,237 kc. Fone
6:30 P.M.- 7:00 P.M.	14,254 kc. CW
7:00 P.M.- 7:30 P.M.	14,254 kc. CW
9:30 P.M.-10:00 P.M.	3950 kc. Fone
10:00 P.M.-10:15 P.M.	14,237 kc. Fone
11:30 P.M.-12:00 A.M.	1760/1806 kc. CW/Fone
1:00 A.M.- 2:00 A.M.	3825 kc. CW
2:00 A.M.- 3:00 A.M.	7280 kc. CW
7:30 P.M.- 8:30 P.M.	Skeds on 80 meters.

At other times, and on Saturdays and Sundays, operation is devoted to the most profitable use of bands for general contacts and to participation in special week-end operating activities. The station is not operated on legal national holidays.

Give W1AW a call for an accurate frequency measurement, to communicate with any department of A.R.R.L., to rag-chew when time permits, or to pass a message to ham friends, making use of the Headquarters station's multi-band facilities.

Brass Pounders' League

(June 16-July 15th)

Call	Orig.	Del.	Rel.	Extra Del. Credit	Total
W8GZ	31	86	1508	77	1702
W4PL	9	33	854	31	927
W60BJ	0	420	0	420	840
W6QCX	521	48	157	83	809
W9KG	46	42	694	0	782
W9QIL	65	119	481	112	777
W2SC	27	119	348	114	608
W6PGB	26	85	334	72	517
W3BWT	72	41	366	36	515
W6IOX	20	61	362	59	502

MORE-THAN-ONE-OPERATOR STATIONS

Call	Orig.	Del.	Rel.	Extra Del. Credit	Total
KA1HR	657	536	34	509	1736
W2USA	958	95	44	85	1182
KA1HQ	222	124	410	122	878

These stations "make" the B.P.L. with total of 500 or over. One hundred deliveries + Ex. Del. Credits also rate B.P.L. standing. The following one-operator stations make the B.P.L. on deliveries. Deliveries count.

W6KMM, 418	W6GFO, 162	W7APS, 108
W3QF, 234	W6CFN, 145 ²	W8SCW, 103
W6CFN, 223 ¹	W3HRS, 142	W6CIS, 102
W6CFN, 221 ²	W6CFN, 131 ⁴	W3GKO, 100
W6LUJ, 221	W6CFN, 131	W2PL, 100
W9OMC, 200	W1BDU, 123	More-than-one-opr.
W7GVH, 192	W2LPJ, 118	W1AW, 167
W6NLL, 164	W2LZR, 111	

A.R.R.S

Call	Orig.	Del.	Rel.	Extra Del. Credit	Total
WLTW (W9QIL)	57	81	354	75	567

MORE-THAN-ONE-OPERATOR STATION

Call	Orig.	Del.	Rel.	Extra Del. Credit	Total
WLM (W3CXL)	155	74	1593	51	1873

A total of 500 or more or 100 deliveries + Ex. D. Cr. will put you in line for a place in the B.P.L.

- ¹ May-June.
- ² April-May.
- ³ February-March.
- ⁴ March-April.



400 lbs. of Ham!

Arthur K. Woodman, W4GFN, Palm Beach, Fla. — 6 ft., 7 in. tall, and tips the scales at 400 pounds!! The heaviest ham?

Equipment at W4GFN includes National 600 and Temco 50 transmitters, HRG, SX25, S21 and Howard 450A receivers, National NTE-B exciter, Meissner converter, 28-56-Mcs., Browning frequency meter, Field Strength Meter, R.C.A. Recorder and Triplet Modulation Meter. OM Woodman is a member of the A.A.R.S. and the Old Man Radio Club, and operates on 7- and 14-Mc. c.w. and 28-Mc. phone. The pet cockatoo has been dubbed the "CQ Bird."



How's DX?

HOW:

THE stuff is getting pretty thin these days, and we don't even have a lot of Pacific island stuff to talk about, but that shouldn't stop our getting together for a little re-hash of the situation. Cards are still coming in from DXCC members, so there is probably plenty of writing being done by the gang that is trying to squeeze every last card it can. Some of the cards that are coming in are the worked-over kind, and their only effect is to make the DXCC list a little shorter. Folks just don't seem to take us seriously when it is said that the cards are checked. We were a little surprised at the latest culprit, since it was someone we would never have suspected. Perhaps we need two lists — a DXCC list and an ex-DXCC list!

DXCC ROUND UP:

THE Round Up, held a few months back, seems to have been a bit of a success for a first venture, and it seems fitting and proper that we try another in the near future. According to a cross-check of the logs sent in, there were at least 58 DXCC members active at one time or another during the week-end. Naturally they all didn't have time to go into the thing hot and heavy, but their hearts were in the right place.

Top man was none other than Bill Atkins, W9TJ, who worked 43 DXCC stations during the time. Bill is followed closely by W9DIR with 39, and W6BAM is third with 31. Others for whom we have scores are W8HGW, 28; W4MR, W1JPE, 23; W8OQF, W9VKF, 22; W1BXC, 20; W2GVZ, 19; W9UQT, 16; W1DUK, 15; W8OSL, W9RCQ, 13; W5ASG, 12; W1BUX, W8PQQ, 10; W1APA, 8; W4IO, 5. Others active during the time but not submitting logs include W1FH, W1GCX, W1IAS, W1ICA, W1KHE, W1LZ, W1TW, W2AWF, W2BEW, W2CMY, W2FLG, W2GT, W2GTZ, W2ZA, W3AGV, W3EDP, W3FLH, W4BZ (ex-W4CBY), W4CEN, W4TO, W4TZ, W5KC, W6GAL, W6GRL, W6TJ, W8BTI, W8CRA, W8DHC, W8DWV, W8JAH, W8LEC, W8LYQ, W9ARL, W9CWW, W9GKS, W9HUV, W9JDP, W9RBI and W9VDY.

W9TJ sent in a rather complete log, and we like the looks of it so much we're going to reprint it as is, to give you an idea of what went on. (Bill moaned a lot about all signals sounding like DX, the ingrate. We arranged that specially, to make the boys feel at home.) His log:

Call	Remarks and Stuff
W1BUX	Short and snappy!
W1BXC	Should have quit after this one.
W1JPE	Mother was right. . . . Strangers are dangerous!
W6BAM	The sleepless wonder . . . on every minute.
W2BEW	Stopped "feuding" and worked the guy!
W4CEN	Keeps the Charlotte cops jumping . . . via radio.
W6GAL	The originator . . . in person.
W8HGW	Larger type would make a better column.
W1ICA	Says he doesn't like war. . . . QSL's disappear!
W4MR	Sounded like AC4YN . . . I guess!
W2FLG	Conditions better . . . he's up to S3.
W8LEC	A radio inspector can do no wrong!
W1APA	Another guy having "geographic advantage."
W8OQF	Ralph going to 56 Mc, where the DX is.
W2AWF	Hasn't worked AC4YN "yet."
W2GVZ	Says DX stations answer him as "W2GTZ."
W8DWV	A student, tutored by Frank Lucas.
W1IAS	Conditions worse . . . he's down to S2.
W1KHE	Asks, "Can I participate with 94 confirmed?"
W1DUK	Says, "Wouldn't it be nice to be a W6?"
W6TJ	Hurrah . . . kin-folks!
W9DIR	Herb Becker's pet W9!
W9VDY	His signal as hollow as Uncle Herman's leg.
W9GKS	Needs Valdostio for "WAVCPTR."
W9CWW	Leavenworth's pride . . . outside the walls!

W8BTI	Says it's easy to work AC4YN.
W8OSL	Says he never used a "beer-can vertical."
W1LZ	Scoop! . . . 2000 volts cannot be used on Eimac filament.
W2CMY	Another TWA member . . . where is Tibet?
W5ASG	Simplified sending . . . with either foot.
W2GT	Ed Hopper? 'nuff sed!
W5KC	Will send no Christmas cards this year.
W2GTZ	Sends a kitchen sink with each QSL request!
W4TZ	'The lady killer.
W6GRL	Needs Mars and another dot on his "h's."
W2ZA	What is this "CQ CO"? QST should print more copies.
W3EDP	Believe it or not, a W3!
W4BZ	Pat says "W4CZY too long for DX. Now I'm W4BZ."
W1TW	"I can work DX . . . even if my name is 'Jefferson.'"
W9UQT	The only W9 who hasn't worked W6QD.
W4TO	A Meissner jobber. . . . I bought the drinks!
W1AB	Wants to be top man . . . in the BPL!
W4IO	Met him in a brewery . . . he walked out!

All of the gang who wrote in thought the Round Up a lot of fun, and they were unanimous in wishing it repeated several times a year. Most were in favor of putting no contest angle on it, since that might destroy the rag-chew slant that made it so much fun. We'll schedule another in a few months and, in the meantime, if anyone has any ideas on the thing we'd be glad to hear from him. With about 125 or 150 fellows active in the next one we could really tear the band apart. Is 14 Mc. the best bet, or should we make it a two-band affair? Personally, we think that a two-band job would take on the dimensions of a "sleepless week-end," and we already have other activities (radio, of course) that do that. But we're open to suggestions.

WHO:

W2GT pulled a nice one in getting a letter of confirmation from VP8AD in the South Georgia Islands. Ed worked the fellow just before he was closed down. VP8AD is our old friend from the Falkland Islands — he hopes to be back on as soon as it is allowed The boys around Pittsburgh had a DX meeting over the week-end of the Round Up, which explains why they weren't more active. W8OSL, who sent in the dope, says 18 DX-ers were present. W8OE showed his EA9AH card, W8QFL had one from YJ2BB, and W8JSU sported QSL's from EA6 and ZK. Our spy tells us that W8OSL collected enough beer cans at the party to build another 14-Mc. vertical W1EFM writes that he just worked KF6SJJ, so we know at least one station is active out that way And W1AW tells us that KH6SHS will be active out there until January, 1941. He hopes to have more regular operating hours in the future If you still haven't received your card from VU7BR, and you should have by now, drop a card for forwarding to W8GER PK1TM writes in with a list of DX heard which includes W1CQR on 'phone, the rest being XU's, PY's, and KF6JEG, K7FOS and K6PAH. PK1TM will be glad to QSL anyone who still has a card due him There seems to have been some trouble with VU2LK as the QSL Bureau in India, so if any of your cards for VU didn't get replied to, you might try again, direct or in care of VU2LJ. G2MI sends the dope W9DIR ran into plenty of tough luck when lightning bit his shack and destroyed most of his gear. But he has the old spirit, and will be back on again presently, quite likely with adequate lightning protection Speaking of lightning protection, if your antenna uses a closed stub for matching, the center of the stub can be grounded to give you continuous protection without impairing the r.f. operation in any way. Other types of antennas can be grounded through a good r.f. choke at a current loop.

The
NC-200
?

IT HAS been National's custom to use this page to say something about each new receiver when it first appeared. In the past our comments have been rather brief, but this time we are going to spread ourselves a bit, partly because there is a lot that we can say about the new NC-200 and partly because we would like to give the amateur the same sort of facts about the new job that a commercial buyer would expect.

The NC-200 was designed by a group of amateurs here in the National organization, which is why it so exactly fills an amateur's requirements. Jack Ivers, W1HSV, and Dana Bacon, W1BZR were responsible for the electrical design with the help of half a dozen others. Bill Larkin, who contributed most to the mechanical design, is the only man in this group who does not yet have an amateur ticket. We think they have done a swell job, for reasons which will be clear when you have read further.

The NC-200 has ten calibrated coil ranges. Six of these ranges provide continuous general coverage from 490 KC to 30 MC. The remaining four ranges cover the 10, 20, 40 and 80 meter bands, each band being spread out over the major portion of the dial scale. This uniform, calibrated bandspread is patterned after the system used so successfully in the HRO, but unlike the HRO, any range can be selected by a knob on the front panel. The movable coil system developed for the NC-100 is also used, since it has proved both its high efficiency and its convenience. The inertia-type dial drive has a 30 to 1 ratio. All in all, we think the system sets a new high for ease in tuning.

New RF coupling circuits developed by Ivers et al have made it possible to maintain full sensitivity up to the highest frequencies covered by the receiver. Specifically, an input signal of only one microvolt will provide one watt of audio power. However, a more striking proof of the efficiency of the RF circuits is the fact that the signal-to-image ratio is better than 30 db at 10 meters, a figure higher than that found in the majority of receivers having two preselectors. Of course, this kind of performance requires more than just an advanced circuit. Molded polystyrene coil forms are used in all circuits, both RF and IF, for instance. However, we will not try to make a list of all the places where air-dielectric condensers, Isolantite insulators, etc., are used, because you have probably seen the inside of a National receiver, and know how they are built.

Frequency drift has been reduced to a minimum through the use of temperature compensators not only in the high frequency oscillator circuit but in the RF and first detector circuits as well. We had a lot to say about this last month on this page, so we will not say much about it now, except to say again that the compensation is darn good.

This about uses our available space this month, so we will finish up our remarks in the next issue of *QST*, where you will find us on this page as usual, with a lot more to say than we have room for, also as usual.

WILLIAM A. READY



Get *Quiet* Reception with **MALLORY** NOISE FILTERS

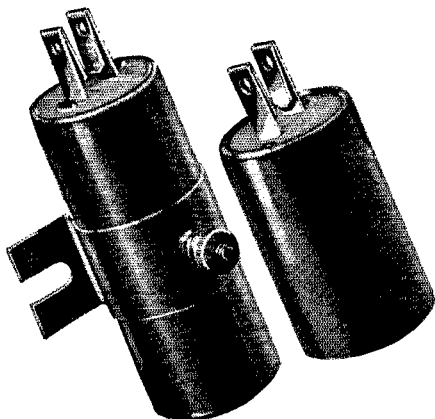

DX no longer need be hashed by the crashes of man-made static originating from nearby sparking electrical appliances. Quiet reception is desirable for the enjoyment of broadcast programs. But quiet reception is vital in communication work. Important messages must not be blotted out—service must not be delayed.

Elimination of man-made radio interference is simple and inexpensive with Mallory Noise Filters. These scientifically designed filters are the product of long research on the part of Mallory engineers. They are inexpensive and easy to install. Selection of the correct filter for each application is made simple by following the instructions in technical data folder Form NF-100.

Enjoy clear reception—get complete data today. Ask your Mallory Distributor for a copy of Form NF-100, or write—

P. R. MALLORY & CO., Inc.
INDIANAPOLIS INDIANA
Cable Address—Pelmallo

Use
P. R. MALLORY & CO. Inc.
MALLORY
APPROVED
PRECISION PRODUCTS

The choke will allow charges to drain off but wouldn't be much good during a direct hit. However, the chances of the direct hit are quite small if the charges can be leaked off before they build up VP6MY writes to say that he has been unable to QSL every station worked, but he is now in a position to verify every contact upon receipt of a card. The address is R. N. W. Gittens, P. O. Box 227, Bridgetown, Barbados W7GZB worked KC6OKS (7190 T9), who will be back in the states in October and QSL from his Oakland QTH, where cards don't cost 35 cents a crack to mail W7HOJ is justifiably proud of working KE6SRA with only 15 watts input There is a little discussion about what continents the KC4 stations rate. According to the I.A.R.U. continent definition, KC4USA at the west base is in Oceania, and KC4USB at the east base is in South America. Before any argument starts, we'll say that the I.A.R.U. definition is the one we go by for WAC awards, and we know that there are certain disputed boundaries over which the geographic experts don't agree. But it's the standard we use and it normally does all right, except when someone tries to squeeze an Asian contact out of a European one. You remember, don't you, when we used to work Europe and Asia? W9TJ, bored because he has no DX to work, suggests a new game called "DX Poker." Asian cards count as blue chips, African cards as red ones, and all others as white ones. The game is played the same as any other poker game, and the cards are acceptable as DXCC evidence. At that, it would be more honorable than fixing them over the way some people we could mention do Several fellows have written in suggesting a "Worked All U. S. Possessions" awards, which would include all the Pacific islands, all W and K districts including KC4. The award is out because of pressure of other work in the C.D., but we'll be glad to record any and all who have done it Which brings up the question of QSL-ing a television contact — is a photograph of the image on the screen sufficient, or shall we exchange cards? Jeeves suggested we exchange photographs, but that wasn't until after he read a story on YL operators Next month we'll give you a list of what some of the top-notchers in the DXCC have submitted to get such large totals — right now we have to dash over to the garage to fill up with DX gasoline, grab some salad made from CQ-brand potatoes, breeze out to the golf course to knock a DX-brand golf ball for a score that will put us in the DXCC, and finish off with a tall one mixed with Century Club bourbon. DX dies hard!

— WJJE

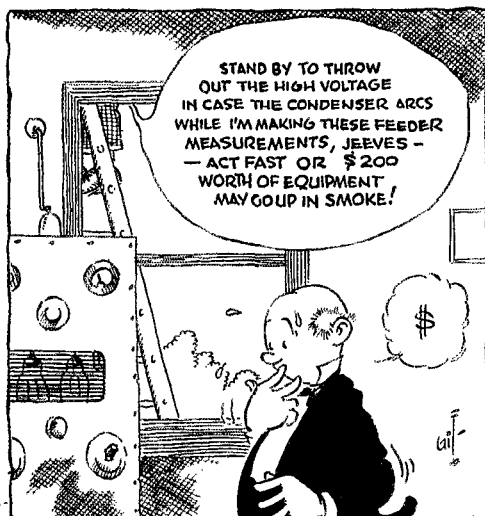

BRIEFS

Rear Admiral Hooper spoke at a recent Washington Radio Club Annual Dinner. He lauded A.R.R.L., and especially our "Key Men," "Knights of the Brass." As he expressed it, our c.w. men, operators, are one of the United States' greatest reserve assets. He said 'phone was of limited uses in time of war, easily intercepted and impractical for cipher, coded orders, and uses not meant for spot execution and action.

Another of the world's leading amateurs
who uses Eimac Tubes.

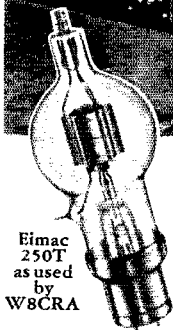
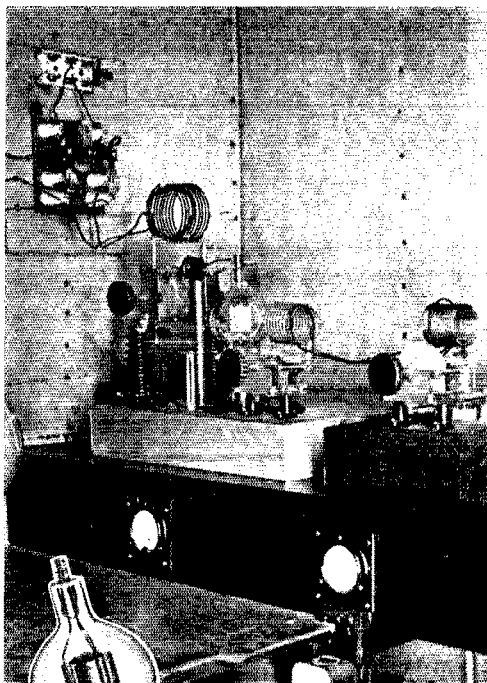

Eimac
250T
as used
by
W8CRA

One of the five amateurs who first won Century Club membership in December, 1937, Frank's score of 112 countries ranked him number one

at that time. Since then he has been consistently out in front and as the record stands today he is in second place following another Eimac user, W6GRL. The outstanding success of Station W8CRA has been achieved and maintained through Frank's careful study and application of good equipment. Frank Lucas knows that the outstanding performance capabilities of Eimac tubes have been responsible for many a record-breaking performance. That's why Station W8CRA, like most of the other leading amateur stations of the world, is equipped with Eimac tubes.

Here's something for you to remember whether you are interested in DX or simply "Chewing the Rag": What Eimac tubes have done for others they can do for you. See your nearest Eimac dealer or write direct for information.

Eimac
TUBES

Eitel-McCullough, Inc., San Bruno, California

One of the First Members of the DX Century Club **FRANK LUCAS** **W8CRA**

says: "I find Eimac Tubes superior to any I have ever used. They certainly can take a lot of punishment"



Frank is smiling
over the good luck
he is having with
Eimac Tubes

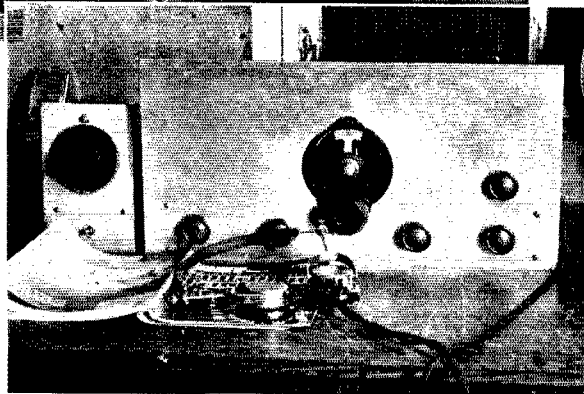

Upper photo shows general view of the transmitter. Above is a close-up of Frank's receiver

EIMAC REPRESENTATIVES

California, Nevada
HERB BECKER, 1530 W.
104th St., Los Angeles, Cal.

Wash., Ore., Idaho, Mont.
GENERAL SALES CO.,
Verner O. Jensen, 2605-07
Second Ave., Seattle, Wash.

Colo., Wyo., New Mexico,
Arizona, Utah
RICHARD A. HYDE, 4253
Quitman St., Denver, Colo.

N. Y., N. J., Penn., Md., Del.,
Dist. of Col., Maine, N. H.,
R. I., Conn., Mass.

ADOLPH SCHWARTZ,
14726 Elm Ave., Flushing,
New York.

N. Caro., S. Caro., Georgia,
Tenn., Flor., Ala., Miss.
JAMES MILLAR, 516 Ninth
St. N. E., Atlanta, Georgia.

Texas, La., Okla., Ark.
J. EARL SMITH, 2821 Live
Oak St., Dallas, Texas.

Chicago, Illinois, Wisconsin
G. G. RYAN, 549 W.
Washington Blvd., Chicago,
Ill.

Ohio, Mich., Ky., Ind., Minn.,
Mo., Kan., Neb., Iowa
PEEL SALES ENGINEER-
ING CO., E. R. Peel, 154
E. Erie St., Chicago, Ill.

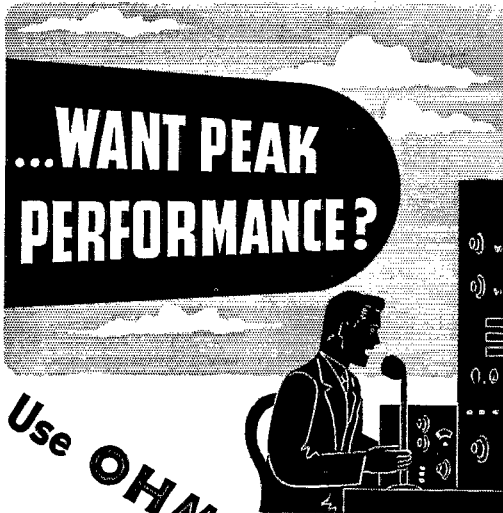

Use **OHMITE** Parts

It's one of the surest ways of keeping your rig in tip-top shape — of knowing you'll have long, continuous trouble-free performance day in and day out. *Everyone* knows that Ohmite parts are built for extra efficiency — that's why thousands of amateurs all over the world make it a habit to ask their Jobbers for Ohmite Resistance Units.

Rheostats ... Keep power tube filaments at rated value for best efficiency and long life. Sizes from 25 to 1000 watts.

Brown Devils ... Extra-sturdy 10 and 20 watt vitreous enameled resistors for voltage dropping, bias units, bleeders, etc.

Parasitic Suppressor ... Small, compact resistor and choke designed to prevent u.h.f. parasitic oscillations.

R. F. Plate Chokes ... Avoid fundamental or harmonic resonance in the amateur bands. 1000 M.A. rating.

Write Today for Catalog 17 ✓

OHMITE MANUFACTURING COMPANY
4865 Flournoy Street ★ Chicago, U. S. A.

OHMITE
RHEOSTATS RESISTORS TAP SWITCHES

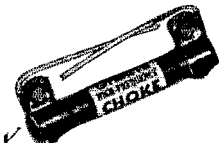
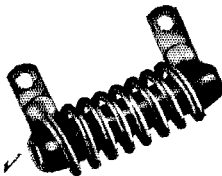
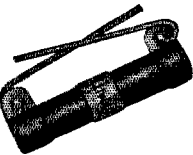
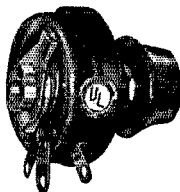

DX CENTURY CLUB AWARDS

These have been made to the first-listed amateurs, based on contacts with 100 or more countries, the credits all certified by examination of written evidence under the award rules.

W6GRL..... 151	W8DHC..... 133	G5RV..... 122
W2GT..... 150	W5BB..... 133	W8NJP..... 122
W8CRA..... 147	W2CMY..... 133	W9TB..... 122
W2GTZ..... 147	W1FH..... 133	W1AXA..... 122
W2GW..... 146	W8OQF..... 132	W6GAL..... 121
G6WY..... 145	G6RH..... 132	W9FS..... 121
W1TW..... 143	W4BPD..... 132	W2GVZ..... 121
W9TJ..... 142	W3CHE..... 132	W5KC..... 121
G2ZQ..... 141	HB9J..... 129	J5CC..... 120
W6KIP..... 140	W2HHF..... 129	W7AMX..... 119
W1BUX..... 139	W2UK..... 128	W9ADN..... 119
W8DFH..... 139	W3EPV..... 128	W1JPE..... 119
ON4AU..... 139	W8LEC..... 127	W1IAS..... 119
W8BTI..... 138	W2ZA..... 127	ZL1HY..... 118
W1SZ..... 137	W9KG..... 126	W2BYP..... 118
W5VV..... 137	W9ARL..... 125	W1ADM..... 118
W3EMM..... 137	W8DWW..... 124	W8MTY..... 118
W6CXW..... 135	W8JMP..... 124	VK5WR..... 117
W1TS..... 135	W1DF..... 124	W1HX..... 117
W8ADG..... 135	W3FRY..... 124	W8QXT..... 117
W1LZ..... 134	W4CEN..... 123	W9EF..... 116
W8OSL..... 134	D4AFF..... 123	W3EVW..... 116
W2BHW..... 134	W9GDH..... 122	W4CYU..... 116
W2JT..... 131	W3EDP..... 122	W4DRD..... 116

- 115: W6ADP, W2CYS, W1WV, G5BD
 - 114: W9KA, W8BKP, W2DC, WICH, G2DH, G5BY, W3BES
 - 113: G6CL, W2CJM, W2DSB, W2GRG, W3FPQ
 - 112: W6FZL, W3EVT, W3GAU
 - 111: W2AAL, W1DUK, VE2AX
 - 110: ON4UU, PA0XF, W9UM, W2AER, W8IWI, W1ICA, W1BXC, W5QL, W2ARB, W2IYO
 - 109: W3DDM, W6FZY, G2MI, W2AV, W8LFE
 - 108: W6HX, ZS2X, HB9BG, W3BEN, VE3QD, HB9CE, W9CWV, VE3QK, W2GNQ
 - 107: W2CBO, G5BJ, W3AG, VK2DG, W1BGY, VK3CX, W7DL, W6MVK, W9RBI, W6AHZ
 - 106: G2TR, W8EUY, W6TJ, W9UQT, ZJJJ, W1ZI, W1RY, W2VY, W3GEH, W9VDY
 - 105: W2OA, G5QY, W1GDY, HB9X, W2IOP, W4TO, W1GNE, W2BMX, W8LYQ, W8JAH, W3ZX, VK6SA, W1IOZ
 - 104: E1SF, W1ZB, W4AJX, F3RR, W1GCX, W3KT, W8DOD, W4IO, W8HGW, W4BVD, W8PQQ
 - 103: G6PK, W8KKC, W5CUJ, W9RCQ, W6BAM, W9NNZ, W3AGV, W8JTW, LUBEN, W8AAJ, LY11
 - 102: W4C8Y, W8AU, W8OXO, W1FTR, VE2EE, W2BXA
 - 101: F8RJ, VK3KX, W6DOB, SUIWM, W1CC, SUI5G, G6MK, W4MR, W6GHU, W6KWA, W4EQK, LU7AZ, W1AB, W1AVE, W6ATI, W1CBZ, W2BJ
 - 100: G6NF, W6KRI, VK2ADE, ZL1GX, ZL1MR, PA0QF, W8BSF, D3BMP, W9LBB, W4CCH, W8KTW, W5ASG, W8JIN, W8QDU, G6GH, W3AIU, W9LQ, W2JME, W4TZ
- Radiotelephone: W2AZ 106; W2GW 105; W6OCH 101.

The following have submitted proof of contact with 75-or-more countries: W8AJA, W9JDF 99; G3JR, W2ALO, W3A00, W2CTO 98; W4TP, W6MEK, W8TT, W8LZK 97; G8IG, W3FLH, W4DMB, W8BOX, W1CO1 96; F8LX, F8SAB, G6XL, W1KHE, W3EMA, W3OP, W8IQB 95; K4ESH, W3GHD, W8CJJ, W8AEH, W8BEZ 94; G8ZO, ON4GK, PA0GZ, W2WC, W8PKZ 93; SP1PL, W4F1J 92; W1BGC, W1DOV, W1KID, W9G6J 91; D3CCS, G6YR, ON4FE, SP1AR, W8LAY, W9OVU 90; VK3HG, W2BZB, W2GDU, W6AM, W8AAT, W8JFC, W9VKF 89; G2DZ, W3JM, W6NLZ, W8PG8 88; P2ZDN, W8QPB, W6LDJ 87; W1APA, W2PLG, W8DAE, W8OUK, W9FLH 86; VK2TI, W4AEF, W4CFD, W6GF, W8BWC, W5GMI 85; SM5WL, W1BPT, W1BPN, W2AYJ, W8BWB, W8CED, W9GKS 84; E1AJ, OZ7CF, VE2GA, W2AWF, W6DTB, W6KUT, W8BFG, W9DIR 83; W1EWD, W3AYS, W3FUF 82; J2LL, W2HTV, W3EUJ, W9GY 81; G3BB, LA2X, W2BNX, W3BVN, W3EPR, W4OG, W6MHE, W8GCP, W8TK, W8CMY, W8MRV 80; W4ZZ 79; W3DRD, W4EPY, W8FJN, W0YB 78; W6QAP, W9HUV, 77; PA0MW, W1EH, W3BSB, W3CRW, W3FHY, ZL1J 76; HEZMC, VE3DA, W1NI 75.

Radiotelephone: W2LXY, W4CYU 98; G5RV 92; W6LFE 90; W3EMM 89; W1ADM 87; W1AKY 84; W2IK 80; W6IKQ, W8QXT 78; W1BLO 77; W9TIZ 76; W2GRG 75.

Since more personnel time will be required for issuing the Code Proficiency Certificates, the next listing of Century Club Awards and standings will be scheduled for December QST.

CHOCK FULL OF PLUS VALUES!

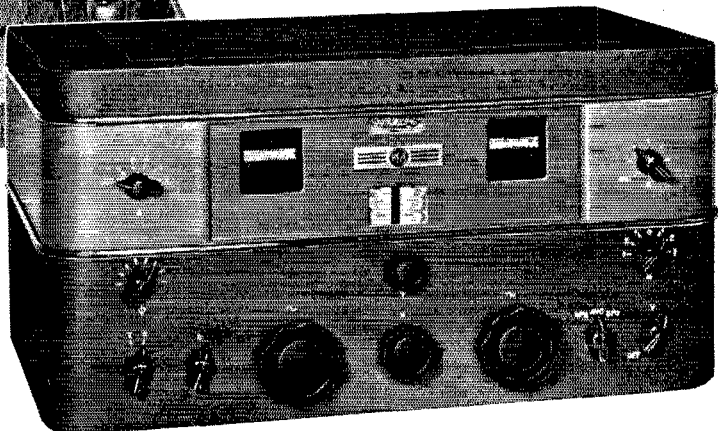
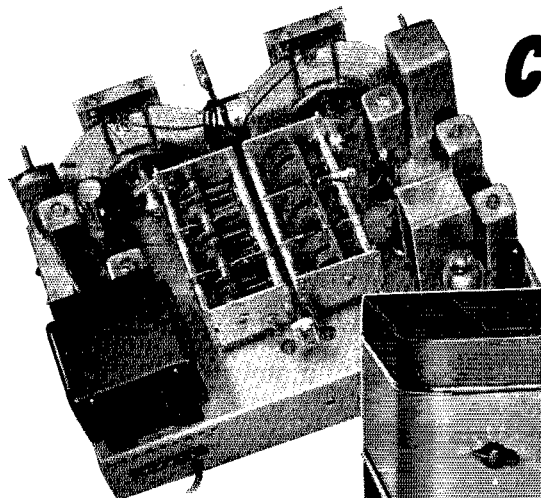

AR-77

COMMUNICATION
RECEIVER



Double-Purpose Value

During off periods of "QSO-ing", when you are busy with the soldering iron and pliers experimenting or just relaxing, you will want to have some good entertainment programs permeate the shack. To meet this extra requirement, we offer a new Extended Range Loud-speaker MI-8314-A for the AR-77. A combination hard to beat for faithful reproduction of all modulated signals.

Amateurs' Net Price for both AR-77 Receiver and MI-8314-A Speaker \$154.50

"STAY-PUT" TUNING

Tests under average conditions show maximum drift at 30 Mc to be only 3.0 Kc on one hour run, thereby keeping signal audible.

ADJUSTABLE NOISE LIMITER

Can easily be regulated to meet local conditions. Easily understood signals obtained through noise peaks hundreds of times higher than signal level.

"BREAK-IN" OPERATION

Used on a separate antenna, receiver recovers instantly when transmitter key is up. Ideal for "traffic hounds" to move a hook full of messages promptly. *(Receiving antenna should resonate in higher frequency band than transmitter frequency to prevent excessive voltage pick-up from transmitter.)*

HIGHEST SIGNAL-TO-NOISE RATIO

A 2-to-1 ratio of signal-to-noise is obtained at an average sensitivity of 2 microvolts throughout range.

Give it a Whirl!

Other worthwhile features of the AR-77 include Uni-view dials; accurate signal reset; standby switch with relay terminals; temperature and voltage compensated oscillator; high-gain pre-selector stage and a popular tuning range of 540 to 31,000 K. C. Write for Bulletin—or, go to your nearest RCA Amateur Equipment Distributor and compare the performance. You be the judge! Amateurs' Net Price \$139.50. MI-8303 Table Speaker in matched cabinet \$8.00 extra. All prices f. o. b. factory.

UNIFORM SENSITIVITY

Each r-f circuit has dual alignment with air-dielectric trimmers for high-frequency end and inductance adjustment of coils for low end.

BANDSPREAD TUNING

Calibrated bandspread for 10, 20, 40, and 80-meter bands extends to nearly full rotation of dial for "split-kilocycle" readings. *Carrier level meter* serves for both peak tuning and to measure signal strength in popular "S" scale.

6-STEP SELECTIVITY

Wide choice of selectivity assures operator control of signal interference.

IMPROVED IMAGE REJECTION

Image ratio of approximately 40-1 at 30 Mc is obtainable.

NEGATIVE FEEDBACK

Smooths out and extends the audio response curve.



for Amateur Radio

RCA MANUFACTURING COMPANY, INC., Amateur Division, CAMDEN, N. J. • A Service of the Radio Corporation of America



LOW PRESSURE
"Feather Weight"
CRYSTAL PICKUP



**PERMANENT
 SAPPHIRE STYLUS**



LONG RECORD LIFE



NO NEEDLE CHANGING

Who can resist these modern changes and improvements in electrical phonograph reproduction? One ounce needle pressure, or approximately only one third of that necessary with conventional pickups, reduces record wear and assures long record life. At the same time, wear-distortion and surface noise are reduced to a negligible minimum. But best of all, Astatic Crystal Pickup Models FP-18 and FP-38, are equipped with permanent sapphire styli. This eliminates the necessity for changing needles and adds much to the full enjoyment of phonograph reproduction.

LIST PRICE \$16.50

*See Your Astatic Jobber or Write
 for Astatic Catalog*



ASTATIC

Microphone Laboratory, Inc.
 Youngstown, Ohio

Licensed Under Brush Development Co. Patents

ARTICLE CONTEST

With the presentation this month of the prize-winning article by L. R. Mitchell, W1HLL, the virtues of all bands from 5 through 160 Meters have been extolled by various writers. Articles are invited on the subject of "the most interesting amateur band." Why not tell the gang about your favorite?

If you prefer to try your hand at a contest article on a different subject, we suggest that you tell about what activity you find most interesting in amateur radio. Here you will find an almost limitless variety of subjects. Perhaps you would like to write about working for code proficiency, participating in League contests, keeping schedules for traffic work, working in Section Nets, holding a League appointment, working on radio club committees, organizing or running a radio club, or some other subject near to your heart.

Each month we will print the most interesting and valuable article received. Please mark your contribution "for the C.D. contest." Prize winners may select a 1940 bound *Handbook, QST* Binding and League Emblem, six logs, eight pads radiogram blanks, DX Map and three pads, or any other combination of A.R.R.L. supplies of equivalent value. Try your luck!

The Most Interesting Band

BY L. R. MITCHELL, W1HLL

IT HAS BEEN my impression that there is a great deal more to be gotten out of amateur radio than just the fact that we make a contact with another person, talk our rig, etc. It is my opinion that there is a great deal to be gained by meeting personally the people with whom we come over the air. Some of my own closest friendships have been the outcome of QSO's. Then again, there is the matter of public service, service to our country and the government which supports our activities, and the opportunity to take part in A.R.R.L. sponsored activities. In other words, to get away from the personal aspects for a bit and see how our band gives us the greatest opportunity to make use of that I have outlined.

As I look back over a number of years of amateur radio, through old log books and at all the old QSL cards I think of all the friends, and I mean *personal friends*, that I have made, there is only one band which seems to be tailor-made to fill the bill as outlined above. That is the 160-Meter band. To be of interest to the greatest number a thing must be inexpensive, simple and foolproof, since few of us have any great amount of money to spend nor are they all engineers. It is very easy to get a rig on the 160-Meter band and a low-powered, low-cost, and very simple rig properly operated will give far more pleasure and allow one to get the most out of getting full measure out of amateur radio. For example, a number of years ago I operated a 80-Meter c.w. rig consisting of a '10 TNT with about 25 watts input. The antenna was 132-foot end-fed. Many contacts were made, but few were local and no personal contacts were made as a result of this operation. I then decided to give 160 a try. Coils were wound, the antenna made a new antenna and a transformer and mike put in place of key, series inductance, and any station within 50-mile radius was contacted many times and some fine friends were made.

After seeing what could be done with a rig of that type I built up a '47-'46-'10 rig modulated by 27-50 in 100 type modulator, for those times a modern rig and the word; 25 watts maximum input. With this rig, I had many fine local and semi-DX contacts and made numerous personal friends, among them being three of my best friends. Still using the Marconi antenna and the very low power, a great many QSO's were had over a period of years. In 1936 a number of local hams got together and formed a local net called the Back Yard Net, operating

* 94 Howard St., Melrose, Mass.

(Continued on next left-hand page)

The CENTRALAB Family

of VOLUME CONTROLS

STANDARD

Centralab's non-rubbing contact and long wall type resistor. Available plain, or with one, two, or three taps, and with Underwriters Approved switches.

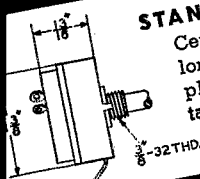

MIDGET

Small in size, large control efficiency. Long straight path of wall type resistor. Available single, dual, or triple, plain, or tapped, with SPST, SPDT, DPST, and a special dial lite push switch for battery sets.

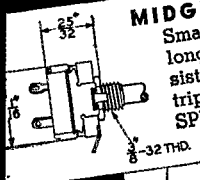

WIRE WOUND RADIOHM

Identical in size with Standard Radiohm. Range from 2 ohms to 10,000 ohms, Rating 3 watts. Furnished plain or with SPST, SPDT, or DPST switches.

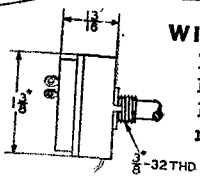

SUB-MIDGET

The smallest diameter reliable control. Wall type resistor gives low noise, rapid transfer of heat to metal shell. Rating of 1 1/2 watts. No switch or taps.

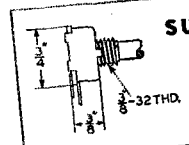

All controls furnished with any desired maximum resistance and with appropriate tapers. Control and resistor problems melt away when you put Old Man Centralab on the job.

TWIN AND TRIPLE CONTROLS

Two or three sections assembled in tandem. Each section fully shielded with all contacts attached to a single shaft. Twin controls available with concentric shafts. Supplied with or without snap switches.

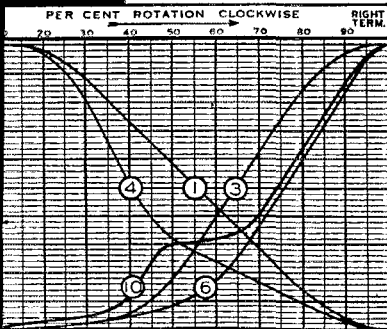
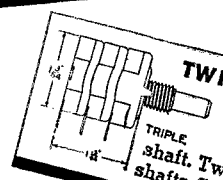

resistor curve of a volume control is more important than its overall resistance . . . that is all Centralab controls are furnished with variety of curves shown here. Curve six is widely used for high resistance radio grid diode controls. Curve 1, or 4, are best for C and Curve 3 for antenna C bias. Curve 10 used on tapped controls.

Centralab

CENTRALAB • 900 E. KEEFE AVE • MILWAUKEE, WISCONSIN
A Division of GLOBE-UNION INC. Cable Address: Centralab Milwaukee

WANTED!

RADIO OPERATORS TO WORK for UNCLE SAM!

*Civil Service Jobs Open
\$1620 to \$1800 a Year!*

Now is the time to show Uncle Sam that his faith in us has been justified. The U. S. Civil Service Commission is receiving Applications for positions from qualified applicants. These positions are of two ratings — \$1620 a year and \$1800 a year.

Vacancies will be filled by the F.C.C., the C.A.A. and other branches of the Civil Service.

The requirements vary according to the rating but necessitate handling code traffic at 25 words per minute or over, 5 years valid operator's license, U. S. citizenship, etc. Duties include standing watch for transmission and reception of radio messages, being responsible for maintenance and operation of equipment, etc.

Additional information, Application Forms, etc. may be obtained at any first- or second-class post office or any U. S. Civil Service office. Ask for **Announcement 93, Radio Operator.**

Those interested in Naval Reserve Appointments should write to Lt. Com. Wycoff, 90 Church St., New York, N. Y.

— K —

Kenyon Transformer Co., Inc. for many years has supplied quality transformers to the United States Army and Navy, C.A.A., F.C.C., Coast Guard and many other Branches of the United States Government. We have also supplied transformers to manufacturers of communications equipment used in these various services — not to mention thousands upon thousands of Radio Amateurs everywhere.

At a time when world conditions call for us to give the best that is in us, we feel that we are rendering not only a public service by giving the widest possible publicity to this announcement but also upholding the faith which the name Kenyon has come to signify in the minds of so many from coast to coast.

KENYON TRANSFORMER CO., Inc.

840 BARRY STREET

NEW YORK, N. Y.

Cable Address: "KENTRAN"—New York

spot frequency of 1952 kc. in the 160 band. Some fine personal friendships were formed. We practised handling traffic, net control and net operation. We studied for Class A license by a series of question-and-answer discussions over the air every Sunday morning, with all net members taking part. Over 80% of the members of this net are now Class A hams. We offered our services to A.R.R.L. in case of emergency, and several of us became O.P.S. and operated in the quarterly parties. Out of these over-the-air meetings grew picnics, little hamfests and visits to each others' homes. As I look back on those days I know I have never since realized the satisfaction out of amateur operation that came from this net. As I have had the time to listen in on 160 I find there a sense of comradeship and friendship so lacking on the other bands.

I became O.P.S. on 160 in 1937. This gave me a chance to take part in interesting O.P.S. parties and to operate my 'phone station in a fitting manner and try to set a fair example for the younger gang who were flocking on the band at that time. I also joined the A.A.R.S., operating in the 160-Meter Phone division. Drilling twice a week gave me valuable training in Army procedure, thus fitting myself to be of some aid to myself and my government in times of emergency. Later I was asked to serve as P.A.M. and then S.C.M. of my Section, all this coming out of operation on one band for 90% of the time. The 160 band certainly offers the opportunity to lead a full life as an amateur and to become a better developed citizen through the activities available. During times of emergency a great many lives have been saved and property damage averted by amateurs operating on the 160-Meter band. Then again, a number of hams are now on the air because some ham was willing to devote some of his time to sending code practise on 160.

To sum up in a few words the things which serve to make 160 such an interesting band: In my opinion, there is no other band which offers such great opportunity for pleasure, personal gain through close friendship, a chance to help others, both in times of distress and in normal times, the opportunity to support and take part in the activities of our League and our government, activities which cannot help but make us more valuable citizens to ourselves and to our neighbors. Long live 160 meters!

— — — —

Hamfest Schedule

September 15th, near San Rafael, Calif.: The Seventh Annual Hamfest of the Marin Radio Amateurs will be held at McNear's Beach, near San Rafael, Marin County, Calif., on Sunday, September 15th. An invitation is extended to all. Come and enjoy a big time!

September 22nd, at Slater, Iowa: The Fourth Central Iowa Hamfest will be held September 22nd at the Log Cabin, City Park, Slater, Iowa. Registration fee of 50¢ for participation in purchased prizes. There also will be donated prizes. Bring your families, and picnic baskets. Free coffee, cream and sugar served. Everyone welcome. Further details available from Ed. Rimathe, Slater, Iowa.

— — — —

WANT TO JOIN A NET?

If you never have been a member of an organized net of amateur stations you have missed some of the best fun in the game. There is a spirit of good fellowship among net members that is not always found in ordinary hit-or-miss ham work. Operation in well-managed nets provides unexcelled training in good operating ethics and procedure, plus excellent code practice in the case of c.w. traffic nets. Why not join up with some organized group this season and enjoy the advantages that come from teamwork?

Many A.R.R.L. Section Nets (both phone and c.w.) and Traffic Nets will be reopening in September. If you are interested in joining one of them, send a card at once to the Section Communications Manager for your Section (list appears in each QST). State in which type of net (traffic, 'phone, etc.) you would prefer to operate. If it happens that no net is in active operation in your Section, it is possible that a new net may be organized if sufficient interest is shown. Your S.C.M. will send you details of existing nets, or will refer your inquiry to the Route Manager or 'Phone Activities Manager who may be in charge. *Act now* so that you will be ready to start when the nets open!

(Continued on next left-hand page)

STANDARD

with Experts

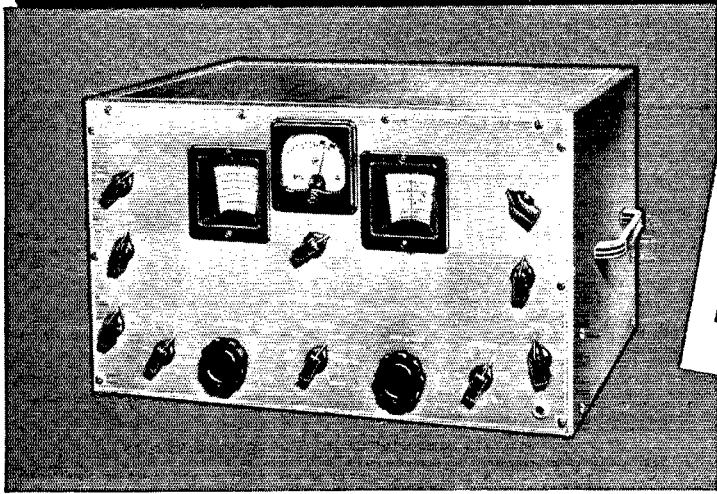
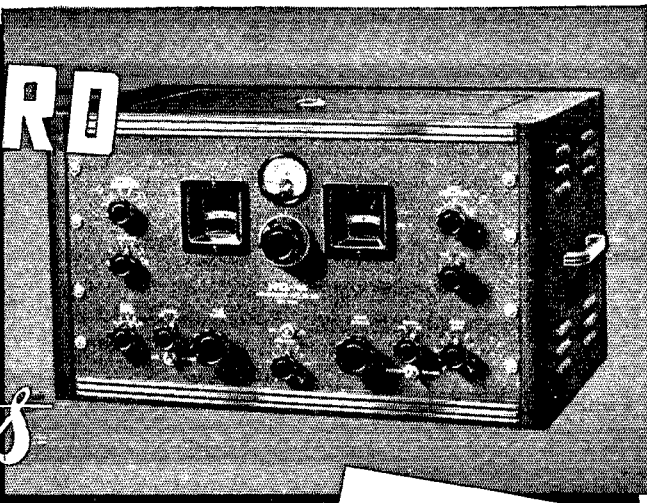

**SUPER
PRO
and
HQ-120-X**

AN enviable record has been established by both the "HQ-120-X" and the "Super-Pro." They have been selected for service from Alaska to the Antarctic and their outstanding performance is continually making new friends. It seems as though the more difficult the service, the more likely you are to find a Hammarlund receiver doing the job. There's a reason for this too. Our receivers are built of parts which are made in our own factory where quality is more important than cost. Every "HQ" and "Super-Pro" has that built-in

quality which can only be appreciated after you have had the pleasure of operating them. Try whichever falls into your price range and you will see why experts use Hammarlund receivers.

MAIL COUPON TODAY!

HAMMARLUND MFG. CO., INC. Q-9
424 W. 33 Street, New York City

- Please send "HQ" booklet
- Please send "Super-Pro" booklet

Name

Address

City State



Canadian Office:
41 West Ave. No., Hamilton

HAMMARLUND

EXPORT DEPARTMENT, 100 VARICK ST., NEW YORK CITY

QUALITY ABOVE ALL!
SOLAR
 CAPACITORS

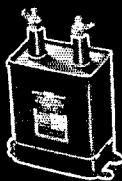

**XL
 TRANSOIL**
 For
 Permanent
 Filters

**XD, XC
 TRANSOIL**
 for Filters
 and Bypass

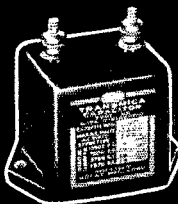
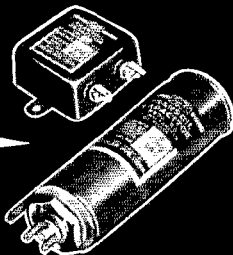

**XA, XH
 MICA**
 Oscillator
 Tank Circuits

**XR, XS
 MICA**
 Tank Circuits,
 R. F. Bypass

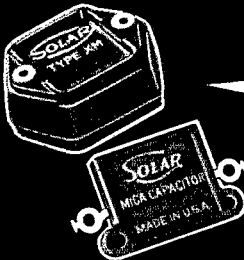
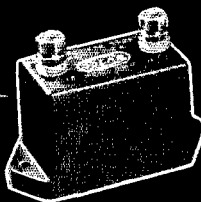

**XM, XQ
 MICA**
 Coupling, Blocking
 R. F. Bypass

**MH, MW
 MT, MO
 MICA**
 Low-voltage

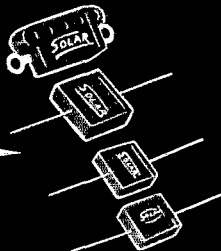

**XT
 OIL TUBULAR
 S**

Wax-Molded
 Paper Tubular

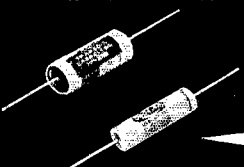

Catalog Free Upon Request

SOLAR MFG. CORP., Bayonne, N. J.

**A.R.R.L. CODE OF CONDUCT
 FOR ALL U.S. RADIO AMATEURS**

1. Do not talk about the war over the air, or even among ourselves, or discuss any happenings that might have a military significance (our signals may be intercepted by belligerents).
2. Do not use any code or cipher*; use plain language, English recommended.
3. Do not permit anyone except members of your immediate family, or other licensed amateurs who at the time are in possession of their F.C.C. licenses, to use the microphone of your phone station.
4. Sign each transmission with your call sign; follow every F.C.C. regulation with utmost care.
5. Scrutinize domestic traffic offered you by strangers; if you are approached by any agent of a subversive group or an agent of a foreign country, communicate immediately with the nearest office of the F.B.I. or via A.R.R.L.

* One exception, authorized AARS/NCR drill

**AMATEURS AID IN SIMULATED
 EMERGENCY**

Demonstrating how private pilots and planes might bring help to isolated communities, the Aircraft and Pilots Association and Relief Wings, Inc., on July 1, staged a simulated emergency in which a hurricane struck Long Island in the vicinity of Greenport. The purpose of the test it was assumed that the country's been laid waste, hundreds of persons were homeless, injured, and that normal communications facilities had been disrupted. Some 100 planes participated, the pilots summoned by amateur radio, theoretically bringing aid and supplies to the storm victims. Amateur operators from New York, New Jersey, Pennsylvania, Connecticut, and Massachusetts assisted. H. S. Boerum, W2KOA, of Greenport, was one of the leaders in organizing help. W2KOA served as the Greenport terminal, with W2KOA at the landing field. Some 70 planes arrived at the provided landing field while 30 seaplanes landed on Island Sound at an emergency base adjoining the landing field. 35 boats of the Eastern Division of the U. S. Power Squadron, an organization of private boat owners, also met at Greenport harbor to aid in the disaster. They had been notified by radio. W2HXQ was on the job operating W2USA, with W1KAT, Guilford, Conn., serving as a liaison between Greenport and W2USA. This was all on 147.1 phone. On 3.5-Mc. c.w. W2CGG, W2HZJ, W2CFE and others participated, including various members of A.A.R.S. and N.C.R.

BRIEFS

W9DIR, Portage, Wis., was struck by lightning on July 10th and completely destroyed, not even one of the strings being left unburned. Equipment destroyed included a T200 final on 14- and 7-Mc. c.w. 225 watts input; 203A final on 1.75-Mc., 225 watts input; 250TH final on 28-Mc., 300 watts input; RME69 receiver; G.E. K80 receiver; Crosley all-wave receiver; E. Mitchell XEC exciter; and all other gear that goes with a station. Dir's entire QSL-card collection also went up in smoke. This included more than 250 VK and ZL cards, nearly 200 G's, and about 400 other DX cards of various countries, as well as more than 1800 domestic QSL cards. To replenish his records, W9DIR would appreciate receiving duplicate QSL-cards from old contacts, both foreign and domestic.

The Washburne Evening School, 400 W. Division St., Chicago, Ill., is offering a course in Amateur Radio, covering theory and code practice. Tuition is \$5.00, which is refunded if the student attends three-quarters of the class sessions. Classes are held on Monday and Wednesday evenings starting September 9th. Students may register September 5th and 6th. George E. Forrest, W9ISM, is instructor.

(Continued on next left-hand page)

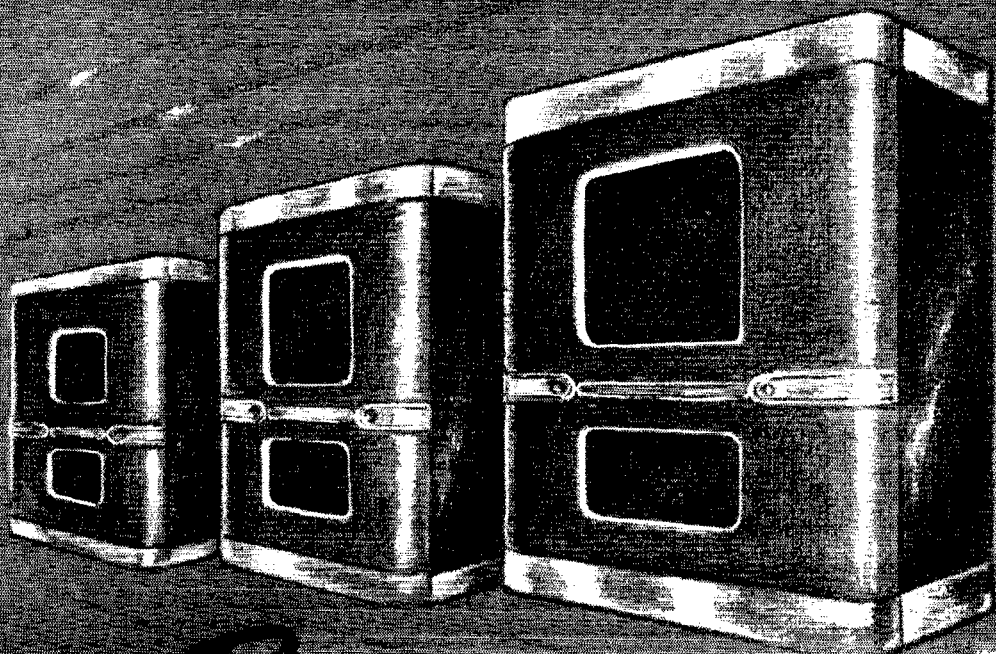

FOR *Better* REPRODUCTION

For better reproduction of speech — with crispness and clarity enough to insure intelligibility at high noise levels — for better reproduction of the broadcast band throughout the entire audio spectrum — Jensen Bass Reflex Reproducers deliver performance superior even to an infinite baffle!

Originally developed for broadcast monitoring, recording and other critical applications they have found wide acceptance in the communications and public address fields.

They are now available as a complete line, with a choice of 8, 10, 12 and 15 inch Jensen Speakers as well as a 15 inch Dual-Unit Speaker.

The enclosures are handsome and the modest prices constitute the greatest values in signal reproduction.

JENSEN RADIO MFG. CO., 6601 S. Laramie Avenue, Chicago

 Jensen
Bass Reflex

REPRODUCTION

GOODBYE TO GUESSING!

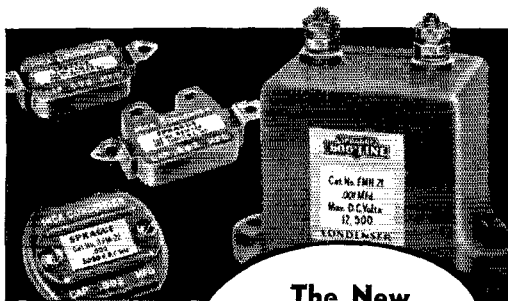

All sizes, all shapes, all voltages

The New
SPRAGUE HIGH VOLTAGE MICAS

You don't have to go looking with a microscope for voltage markings and even then run the chance of making a mistake — not with the Sprague High Voltage Mica Condensers. In designing this new line, we were amazed to find how often voltage mistakes occur. That's why, in addition to offering the finest, most moisture-proof and durable micas, we use different colored labels for each voltage — red for 5,000 volt condensers, blue for 2,500 volt and so on. You know at a glance exactly what you're getting — and, from past experience with Sprague, you'll know their quality cannot be surpassed. *Catalog free.*

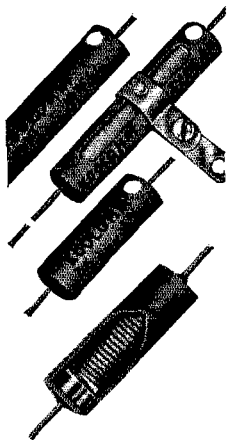

K O O L O H M S
WILL HANDLE THE
JOBS That Ordinary
Resistors Won't!

Look at the construction of Sprague Koolohm Resistors. See for yourself! Common sense will tell you the many advantages of having every bit of wire insulated *before* it is wound with a special heat-proof, moisture-resistant material. Layer windings — larger wire — more resistance in less space — 5% standard accuracy — no chance for shorted windings — cooler operation — inexpensive non-inductive windings — these are but a few of the resulting features which have made Koolohms first choice of leading industrial users for difficult jobs, and "tops" for any amateur radio requirement you can name. *Catalog free.*

Specially insulated wire makes possible new small sizes with layer windings, greater dependability.

Koolohm wire with section of the insulation removed

SPRAGUE

PRODUCTS COMPANY

North Adams, Mass.

South Texas Flood

AT ABOUT 9:30 Sunday morning, June 30th, B. H. Standley, W5FQQ of Houston got word that Hallettsville, Texas, was completely cut off, flooded, needed boats and doctors, and had no outside communication facilities. He immediately called me (W5HNF) on 1.75 Mc. and we began the establishment of an emergency net. In a short time we had things organized here in Houston, but no stations could be heard in the flood area. Other locals were listening and offered their services. W5HSX arranged for a truck from the State Highway Department, and W5FVN had the American Legion portable equipment ready, but about that time W5IVU in Edna, 50 miles from the area, told us that the road was out and there was no way to get in from Houston. With this news, W5IYF offered to help me try to get into the stricken area. We left Houston at noon and went to Schulenburg and then down toward the isolated district. En route it was necessary to cross a wide section where the water was over the running boards, and we were allowed to cross only because of our mission. A few miles south of Schulenburg we found the road gone. People who had tried to cross in boats had lost them and were up in trees where they stayed until the water receded. We went back toward town to the State Highway Warehouse and set up our equipment, contacted W5IVU and gave him our proposed plan.

It might be well at this point to describe the equipment. During the discussions in Houston over the home rig, W5CVQ and W5CTC had been listening. Skinner, CTC, sent me enough 45-volt batteries to furnish 1000-volt plate supply; and Dave Harrell, CVQ, drove up with a portable a.c. supply, a Vibrapack, antenna, and the oscillator from his rig. This is a 6L6 made up like the QSL-40, but with a padding condenser that may be switched in for 3.5 Mc. This little rig proved to be more than ever has been claimed for it. We also took the rig and receiver from W5IYF and my own Sky Buddy and portable transmitter, which is patterned after the rig of W8NCM, as described in August '39 QST. A handful of crystals completed our layout. At the Schulenburg location we had a.c. available, so tied the antenna as high as we could reach to the high line poles along the road. With 16 watts input our signal was strong enough to copy in Edna, 50 miles airline away. The antenna was a 132-foot wire, fed 22 feet off center. It loaded well on both 1.75 and 3.5 Mc. The 'phone rig was that of Everette LaGarde, W5IYF, a 6L6-6L6 with 72 and 6L6 speech.

The water finally receded enough for us to carry the equipment across and go on into Hallettsville in a car. At about 6:30 p.m. we were on the air from the Hallettsville City Hall. During the lapse of time the water had run down from its 8-foot depth in the stores in town, and the power had come back on, so we were able to use a.c. from the mains. We had no more than arrived when the various fire departments on duty came out with their ladders and in no time had the antenna up 40 feet high in the clear, and had cleared the floor and brought tables and chairs. From this time on we were never off the air, and contacted many stations in a 100-mile radius on both 'phone and c.w. Static and QRM were terrific. W5FQQ called the stations on our frequencies and they all stood by. Important traffic was handled, and to the broadcast stations in Houston and San Antonio go thanks for their splendid cooperation in re-broadcasting all of our appeals for doctors, Boy Scouts, boats, and also the flood warnings to other towns in the paths of the Navidad and Lavaca Rivers. Amateur stations that handled our traffic and stood by for us in the twenty-five hours of continuous operation were W5IVU, GAU, NU, HMQ, CVQ, FDR, FQQ, HSX, DIG, BHO, MN, and numerous others. It was late Monday before landline communication was reestablished from Hallettsville, and Ham Radio handled all two-way traffic in the meantime. The people in nearby towns kept their broadcast receivers on us in order to get the reports as they were issued.

Such important traffic was handled as getting in Boy Scouts and C.C.C. men, getting through a message for 1500 ampoules of typhoid serum, and news for United Press and Associated Press, along with personal messages of safety to relatives of the marooned populace. One message was received from W5DIG in Galveston at 1:30 a.m., delivered by Boy Scout three miles out in the country, and the answer filed at 2:30 a.m. Another message to W5FDR for relay to San Antonio for C.C.C. men was 'phone long distance by

(Continued on next left-hand page)



JOHNSON acquires *Bassett*

Antenna and Cable Business

JOHNSON has purchased and moved to Waseca all stock, tools and equipment, engineering data, files and records, and patents relating to antennas and concentric feeder while Bassett continues in other radio fields. The combining of Johnson's 17 years of antenna research and production experience with Bassett's outstanding original development in rotary beam engineering and design promises much for amateur and commercial radio.

Johnson Engineers are making important mechanical and electrical changes, improvements, and additions to combine the two lines. The famous Johnson "Q" and allied antenna materials, the Bassett rotary beam and "Rotomatic" drive, the vertical coaxial, Johnson coaxial line, and Bassett concentric feeder will all be continued. Johnson's customary excellent service will prevail. See your Johnson Jobber or write us direct for latest antenna information.

E. F. JOHNSON COMPANY

WASECA, MINNESOTA, U.S.A.

P.S. A new, bigger and better Johnson-Bassett Antenna Handbook is in preparation and will soon be available through Johnson Jobbers.



Size 3 1/16" x
5 7/8" x 2 1/8"
Amateur
Net Price
\$14.50

Model 666-H is a complete pocket-size tester with AC and DC Voltage ranges to 5000 Volts (self-contained) — as follows: AC-DC Voltage at 1000 ohms per volt 0-10-50-250-1000-5000; DC Milliamperes 0-10-100-500; Resistance 0-300 ohms; shunt type circuit, 10 ohms reading at center scale; 0-250,000 ohms, series type circuit, 3700 ohms at center scale. Higher resistance measurements available by using external batteries. Selector switch for all instrument readings. The ideal Pocket Volt-Ohm-Milliammeter for amateurs, radio technicians, industrial engineers, research. Molded Case and Panel. Completely insulated . . . with RED·DOT Lifetime Guaranteed Measuring instrument. . . . Amateur Net Price . . . **\$14.50**

Model 1696-A — 1941 Modulation Monitor

Carrier Reference Level . . . Per Cent of Modulation . . . Instantaneous Neon Flasher (no inertia) indicates when per cent of modulation has exceeded your pre-determined setting. Setting can be from 40 to 120 per cent. Helps comply with FCC regulations. Has two RED·DOT Lifetime Guaranteed Instruments. . . . Amateur Net Price \$34.84

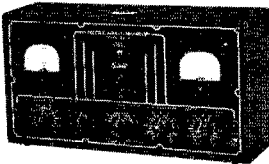

For More Information — Write Section 259, Harmon Drive

THE TRIPLETT ELECTRICAL INSTRUMENT CO.
Bluffton, Ohio

FDR and the reply received by us in less than ten minutes. After twenty-five hours of continuous operation and with landlines reestablished, we decided that Ham Radio had handled its assignment to conclusion, so we took down the antenna and came back to Houston Monday night.

We learned a few things from this operation which we are making effective in this Section now. All equipment must be portable in the sense that it may be carried by hand through any place where it is possible for the operator to go. It must have enough output to work through the heaviest kinds of interference for at least 50 miles and must be adaptable to either utility a.c. or small portable d.c. packs. The receivers must have enough selectivity and gain to overcome the same conditions. A ready cut antenna is a big asset. The low-frequency bands are the only ones of value. 'Phone on 1.75 is better than on 3.9 because there are more outlets among Class B operators, and 3.5-Mc. c.w. is the only band on telegraph not affected by skip for short distance work and where there are plenty of good traffic handling operators.

— R. A. Glover, W5HNF

SOUTH DAKOTA FIRE DRILL

Under the direction of L. C. Anderson of the-Rochford (S. Dak.) Ranger Station, members of the Black Hills Amateur Radio Club on June 30th demonstrated the value of radio in fighting forest fires. Assuming there was a fire near Rochford, amateur operators were sent out to "surround" the fire and report its progress. In less than one and one-half hours the fire, covering an area 10 miles by 15 miles, had been circled by radio contacts and all points had reported to the base camp at Rochford. Wallace Koppmann, W9YOB, A.R.R.L. Emergency Coördinator, Rapid City, cooperated in the work. Others operating Forest Service portables at the various points around the fire area included W9ADJ, W9BLK, W9AKO, W9IWT, W9ANW, Vic Fite, Ted Mirhan, Marvin Egge, Harry Oberg, Henry Harding, Paul Range, Fred Reynolds, Glen Coats, Fred Ferguson and William Richer. The afternoon was spent in sending and receiving messages, shifting radio stations and in other activities necessary under emergency conditions. The "fire" was reported out at 5:30 p.m.

1.75-MC. STATIONS NEEDED TO SEND CODE PRACTICE

Many beginning amateurs find "learning the code" their greatest stumbling block. They call upon licensed amateurs to help them master the dots and dashes but often there are chaps who are unable to get in touch with nearby hams. Each active radio season A.R.R.L. sponsors a program of Code Practice on the "160 meter" band. Operators working on this band are invited to cooperate in this worthwhile work. We were all beginners once and, if we will but think back, we will recall that assistance in getting started was quite welcome. During the past several years the 1.75-Mc. stations sending code lessons have helped hundreds learn the code. This season we would like to have more stations engaged in our program. Just send us the schedule you will follow in sending code practice, being sure to give your frequency (as near exact as possible) and hours and days you will transmit. Please state also on what date you will start transmissions and what date you will conclude same. Code practice stations usually conduct lessons throughout the entire fall-winter season. Hints on how to conduct code practice by radio are sent to all volunteers. The schedules of all 1.75-Mc. code practice stations are mailed to each would-be amateur requesting same — and hundreds of these requests are filled yearly. What say, fellows? Will you lend a hand?

BRIEFS

W6PBV, president of the San Mateo Jr. College Radio Club, advises that anyone in the Bay Region interested in radio is welcome to come to the club meetings on Friday evenings, from 7:30 on (Room 8 in the Science Building of the Junior College).

W6ITH, W6MVK and W6DHS have worked all 58 California counties. W6PBV has only five to go. The Oakland Radio Club has an award for those working all California counties (WACC).

(Continued on next left-hand page)

IMPORTANT FACTS REPEATED!

SAFETY FACTOR DEMONSTRATED

Thousands of amateurs have witnessed W9LIP's demonstrations clearly proving the importance of "Safety Factor." The next time you have a QSO with a midwestern ham, ask him about these demonstrations. He can tell you about the importance of Taylor's Safety Factor—how it protects your tube investment and assures you "More Watts Per Dollar."

300 Watts Tested
-40 Watts Rated
260 Watts
* SAFETY FACTOR



\$3.50

T-40 and TZ-40 NEW RATINGS!
 Filament volts 7.5 V
 Plate Voltage 1500 V
 Plate Current 150 MA
 Plate Dissipation 40 W
REMEMBER—
 Recommended by Leading Parts Distributors

TAYLOR TUBES believes that a Transmitting Tube should be able to stand up to a 1000% temporary overload without injury to any of the elements.
***A GOOD EXAMPLE:** Every Taylor Wonder Tube—T-40 and TZ-40—is factory tested at 300 Watts plate dissipation. The conservative plate dissipation rating is 40 watts, making your SAFETY FACTOR 250 WATTS. This extremely high SAFETY FACTOR is due to the famous "Processed" Carbon Anodes. Suppose a tube in the T-40 class, using a nickel anode, is rated at 40 watts and the nickel anode will melt at 150 watts plate dissipation, your SAFETY FACTOR would be only 110 watts.

The Taylor margin of extra safety is of vital importance, as many tubes are ruined in testing up amplifiers, as stage goes out of resonance, the plate current surges, resulting in plate dissipation far in excess of the tube's normal rated dissipation. It is obvious, then, that the greatest value in protection of your investment, with the highest SAFETY FACTOR represents by far the same SAFETY FACTOR standards are provided for in all Taylor Carbon Anode Tubes.

TAYLOR'S BIG 1940 TUBE MANUAL & CATALOG NOW READY
 Send us five cents in stamps or coin and it will be mailed direct from the factory, or at your parts distributor FREE. Contains new circuits, technical data, tube uses, building information, etc.—a real up-to-the-minute storehouse of valuable information.

Taylor HEAVY **CUSTOM BUILT** DUTY **Tubes**
 TAYLOR TUBES, INC., 2341 WABANSIA AVE., CHICAGO, ILLINOIS
 "More Watts Per Dollar"

From QST, February 1940

TAYLOR TUBES believes that a Transmitting Tube should be able to stand up to a 1000% temporary overload without injury to any of the elements.

*A GOOD EXAMPLE: Every Taylor Wonder Tube—T-40 and TZ-40—is factory tested at 300 Watts plate dissipation. The conservative plate dissipation rating is 40 watts, making your SAFETY FACTOR 260 WATTS. This extremely high SAFETY FACTOR is due to the famous "Processed" Carbon Anodes. Suppose a tube in the T-40 class, using a nickel anode, is rated at 40 watts and the nickel anode will melt at 150 watts plate dissipation, your SAFETY FACTOR would be only 110 watts.

Taylor HEAVY CUSTOM BUILT DUTY Tubes

TAYLOR TUBES, INC., 2341 WABANSIA AVE., CHICAGO, ILLINOIS

FOR DEPENDABLE Test Equipment LOOK AT THE RECORD... NOT THE PRICE TAG!

If you choose your test equipment on performance facts, you'll choose RCP every time, and save money. Price tags do not always insure dependability, nor do they mean that top-performing test equipment can't be had at reasonable cost. Hams who have gone into the test equipment market open-minded, checked test instrument features against price, test instrument ability against ballyhoo came away RCP customers. For it has long been RCP's aim to give you the finest in quality and engineering at the lowest possible cost. Check what you get for your money in these typical test instruments; see if you don't agree: RCP's the value-buy.



PORTABLE AC-DC MULTITESTER



MODEL 446P

Five range DC voltmeter 0/5/50/250/500/2500
Four range DC milliammeter 0/1/10/100/1000
DC Ammeter 0/10
Four range AC voltmeter 0/10/100/500/1000
Three range ohmmeter 0/500/100,000/1 Meg
Four decibel ranges — 8 to 15/12 to 35/26 to 49/32 to 55

It's the equivalent of 25 different instruments in a single case. Separate compartments for test prods and small tools. Appearance, quality and performance put it in a class with testers selling for twice the price. In handsome hardwood case with hinged cover. Complete with batteries and test leads..... **\$11.50**

COMBINATION TUBE AND SET TESTER



MODEL 803

(with mechanical roll chart built in)

This portable "service shop" tests all latest tubes, miniature and bantam, Jr., all filament voltages (at standard R.M.A.). Exclusive measurement method eliminates large errors. Hot interelement short and leakage tests for individual elements. Individual section tests of multi-purpose tubes. Line voltage regulation 103 to 135 volts meter indication. Noise test for tubes which otherwise test good.

DC voltmeter 0/10/50/500/1000 at 1000 ohms per volt
Four range AC voltmeter 0/10/50/500/1000
DC milliammeter 0/1/10/100/1000 DC Ammeter 0/10
Ohmmeter 0/500/5000/100,000/10,000,000
D.B. Meter — 8 15/15 to 29/29 to 49/32 to 55 decibels
Four range Output Meter same as AC volts

In extra heavy wood case with fine Spanish drill grey covering, Bakelite handle — removable cover, and tool compartment. Fused meter. Complete, ready to use with test leads. Model 803 RCP Combination Model..... **\$32.95**

SEND FOR FREE Test Equipment catalog describing entire line of low-cost, dependable RCP Test Instruments.

RADIO CITY

PRODUCTS CO. INC.
88 PARK PLACE, N. Y. C.

BRIEFS

The Milwaukee Radio Amateurs' Club, Inc. has enjoyed continuous activity since 1917, except for the period of the World War. In celebration of its twentieth anniversary the club held an Old Timers Night on December 23, 1939, with eighty youngsters and oldsters in attendance. M.R.A.C. meetings have been held at the Public Museum, Trustees Room, for 20 years without interruption. One of the three original founders, C. N. Crapo, W9VD, is still an active member. Herbert F. Wareing, W9NY, was the president in 1922 and is now very active on the high frequencies. Al Kroner, W9UIT (ex-9ELD), is another old-timer, still active in the club and also as S.C.M. for Wisconsin. W9UIT, W9OT and W9DTK are just a few more of the active old timers in the Milwaukee Club, which is going on to bigger and better things.

Ham activities in Worcester, Mass., took a new twist during the month of June with the organization of the Worcester Women's Radio Association, a group of YL's and XYL's of local amateurs. Meeting at the headquarters of the Worcester Radio Association, the ladies elected the following temporary officers: Mrs. Elizabeth D. Lyons, pres.; Mrs. Malvina M. Salloum, vice-pres.; Mrs. Marie S. Sherman, sec'y; Mrs. Katherine G. Lusk, treas. The objects of the new organization are to further the interests of the YL's and XYL's in amateur radio and to cooperate with the OM's in their ham activities.

Chairman James Lawrence Fly of the F.C.C. in a news conference recently praised the broadcasting industry for its good war news service. As a sidelight on the war situation a survey of the status of the amateur radio service was mentioned, showing the amateurs in the United States a steadily growing group in radio. South American amateur radio too was said to be on the uptrend markedly since the outbreak of the war. To the military authorities in Washington the increase in American amateurs is encouraging, amateurs forming a most valuable reservoir of radio operator reserve material. He pointed out that amateurs in the United States are keeping radiotelegraphy the dominant method of operation — and that radiotelegraphy is considered much more valuable training and demonstration of radio skill than other forms.

The Arrowhead Radio Amateurs had an amateur radio exhibit at the Duluth and Arrowhead Exposition held in Duluth, Minn., April 29th-May 4th. Two rigs were in operation, on c.w.: (W9MBA) HQ120 receiver and P.P. 809's on 7 Mc.; on 'phone: (W9WSB) SX24 receiver and a T200 on 1.75 Mc. A well-prepared circular entitled "What Is a Radio Amateur," written by W9GKO, was distributed to visitors. Among the amateurs participating in the actual operating of the equipment were W9RPK, W9IDX (president, A.R.A.), W9MBA, W9WCA and W9MMS.

An actual emergency trial field meet was held by the Cuyahoga Amateur Radio Association in Brecksville, Ohio, May 19th, due to 61 m.p.h. wind and rain during practice field operations. Operators participating were W8DS, W8TMI, W8DBU, W8PKF and W8NGY, with many other C.R.A. members lending moral support.

The people in Elbow Lake, Minn., don't mind so much if W9YAP comes in on their BC sets sometimes, but when he says that the "band is lousy" they get pretty much up in the air because of such advertising of their high school band over the radiol! Of course YAP is just complaining about the poor conditions on the "160-meter band," but how are the poor BCL's to know!

In conversation with F. E. Cunningham, W9TZQ, Richard Enright of Waukegan, Ill., remarked that he had not heard from his sister since 1930, and that the only clue to her whereabouts was that she lived in Spokane, Wash., ten years ago. W9TZQ contacted W7BAZ of Spokane and asked aid in finding the sister. After several other relays, W7FPN of Aberdeen, Wash., found her in Millwood, Wash., and advised that her brother was seeking her. Brother and sister are now reunited, through the efforts of ham radio.



UNUSUAL MICROPHONE VALUE!
ASTATIC R-3
CRYSTAL MICROPHONE

Output Level.....Minus 52 DB (1V/bar)
 Frequency response substantially smooth from 30 to 5,000 C.P.S. Finished in soft brown with highly polished metal grill. 7' of single conductor shielded cable.

\$5.87

LOW PRICE — NEW IN DESIGN



The New
ECHOPHONE
COMMERCIAL

\$19.95

Perfect as a spare receiver — just the size for your boat — take it with you to your camp or on your vacation.

6 TUBES ■ AC-DC ■ 110V ■ 3 BANDS ■ COMPACT ■ 540 KC TO 30.5 MC ■ ELECTRICAL BAND SPREAD ■ BFO-PHONES OR SPEAKER ■ STAND-BY SWITCH.

TUBES: 1 12KB, 1 12SK7, 1 127Q7, 1 35L6GT, 1 12J5, 1 35Z5
 5-INCH PERMANENT MAGNET SPEAKER



ABBOTT—MRT-3
 2½ METER MOBILE
TRANSCEIVER

\$27.64

20 WATTS INPUT. OPERATES FROM VIBRATOR OR AC POWER SUPPLY

TUBES USED: 1 HY75, 1 6C5, 1 6Y6 or 6L6

Tubes function with (switch on "receive" position) HY75 super-regenerative detector, 6C5 first audio, 6L6 or 6Y6 power audio — switch or "transmit" HY75 oscillator, 6C5 audio, 6L6 or 6Y6 modulator.

Vibrator power supply complete.....\$20.29

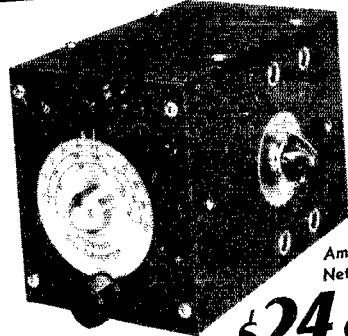

Amateur
 Net Price

\$24.90

Type BL-510

On the Highways or Byways the
Browning 5-10 Meter Converter
 will keep you company

FEATURES: (1) Separate coils for antenna and oscillator circuits for both 5 and 10 meters. (2) Band switch-lator circuit for both 5 and 10 meters. (3) All coils air trimmed as well as air tuned. (4) Oscillator stability assured by voltage stabilization. (5) 2½" nickel silver "Sun Ray" vernier drive dial calibrated in approximate frequencies. (6) On-on switch. (7) May be used with a 1500 KC to 5 MC IF amplifier. (8) Cushioned mounting bracket and shielded leads supplied. (9) May be used with any broadcast receiver as well as auto radio. (10) May be adjusted to cover bands of frequencies between the 5- and 10-meter bands.

Browning 5-10 meter converter complete with tube, laboratory wired and tested. Shipping weight 7 lbs.

KIT OF PARTS
 FOR THE
QST 112 MC
SELF-CONTAINED
BATTERY TRANSCEIVER

Described in April '40 QST on page 28 by Vernon Chambers
 All parts of nationally advertised manufacturers, and as recommended in the original article, drilled chassis and panel including cabinet. Complete instructions, layout blue prints, and diagrams.

Accessories Used in 112 MC Transceiver

- 1 Hytron HY615.....\$2.00
- 1 RCA 6G6G......67
- 1 Kit 4 "B" and 1 6V "A" Burgess batteries..... 4.58

\$10.95

Net price, less tubes and batteries

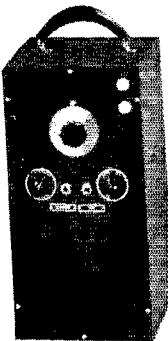

The RADIO SHACK
 167 WASHINGTON ST., BOSTON, MASS., U.S.A.

Can You Answer THESE TUBE QUESTIONS?

Are electrolytic condensers very satisfactory in high frequency work? Yes?.... No?....

Are standard glass tubes and metal tubes interchangeable? Yes?.... No?....

Are class A amplifiers characterized by low efficiency and output with a large ratio of power amplification? Yes?.... No?....

Are electron emissions due indirectly to impact by electrons or ions known as Secondary Emissions? Yes?.... No?....

Does shielding help to keep interelectrode capacities at a minimum? Yes?.... No?....

Are the filaments of 1.4 volt battery tubes heated directly? Yes?.... No?....

Does Sylvania produce as many as 17 different types of panel lamps? Yes?.... No?....

In converter tubes is low frequency drift desirable? Yes?.... No?....

IF YOU aren't positive of the answers to these and thousands of other questions about radio tubes and their application, the latest edition of the Sylvania Technical Manual has all the answers in useful, handy form. 272 pages of information including operating conditions, characteristics and circuit applications on 374 types of tubes. Write to Hygrade Sylvania Corp., Dept. Q90, Emporium, Pa., enclosing 35c for your copy of this great book today.

SYLVANIA
SELF-TESTED RADIO TUBES

K7BUB — Ham Paradise in Alaska

(Continued from page 23)

The ground system consists of about 12 miles of conductor buried radially about the station. All metal objects are bonded and grounded, the receiving room is completely shielded and all power wiring is brought into the station in buried conduit to keep the noise level at a minimum.

At odd moments between press schedules and after station hours, a flick of a switch from the receiving position puts K7BUB's ham transmitter on either rhombic. The rig is a 1-kw. rack job with push-pull 852's in the final. An RK23 is used in the crystal oscillator which drives a 10. A 100TH is used to drive the final. The transmitter incorporates crystal switching and band-switching and a universal antenna coupler. Normal input is 800 to 1000 watts. Provisions have been made for modulating the output with a section of the b.c. audio equipment. A new speech amplifier and modulator are now being constructed for the rig so that it will be an independent unit.

The rhombics showed up to good advantage during the DX Contest in March. Because time was limited, only 216 contacts were made but these were turned out at the rate of one every 3½ minutes for the 12½ hours of operation, which is pretty good considering the difficult path between W and K7. Signal reports averaged S7 plus.

The Wisconsin State Convention

THE Milwaukee Radio Amateurs' Club, famed for their annual "QSO Parties," turned their 1940 efforts to the staging of a state convention — and were not found wanting. From the opening gun, which summoned visitors to inspect the House of Schlitz and start in true Milwaukee style, to the last drawing for a prize, the 250 husbands and wives attending enjoyed themselves immensely.

After a word of welcome from Alternate Director Kreis, W9HRM, the Saturday afternoon sessions opened with a demonstration of two of ham radio's newest gadgets — the electronic key, and an extended variable-frequency crystal control unit — by John Huntoon of League headquarters. Assistant Director Dosland, W9TSN, reported for Director Mathews on highlights of the recent board meeting, and a general open forum ensued. Hytron and Hallcrafters showed motion pictures of their respective manufacturing plants, and during the supper hour many of the delegates visited W9XAO, Milwaukee's experimental f.m. station. Saturday night, as seems now to be amateur convention custom, was devoted to merrymaking under the guidance of a Bohemian orchestra and supplemented by a floor show.

After the Sunday morning group meetings, W9XAO demonstrated the remarkable fidelity

(Continued on page 70)

the
uary 17, 1940

National Bureau of
(Department or establishment)
Washington, D. C. (Address)

INVITATION
subject to the conditions on
May 1, 1940
and then
National Bureau of
Purchas

Sealed bids, in
2 o'clock
re until

lowing supplies, and/or services, for deliv

ARTICLES OR SERVICES

UNIT

UNIT

When Specifications Read

You are Demanding the Best!

A transformer "equal" to a Thordarson means one made under the highest quality standards by an organization with forty-five years of precision engineering and production back of it.

It is little wonder that the word "Thordarson" so often appears in Government specifications.

Thordarson is constantly in production on complete lines of the highest quality Power, Plate, Filament, Driver and Modulation transformers and Chokes. Thordarson production facilities can immediately be turned to meeting the exact specifications of any transformer requirement.

The exclusive Thordarson "TROPEX" process makes transformers impervious to atmospheric conditions in *any part of the world*. It has withstood the most rigid laboratory tests for three years and has performed to expectations in the field since March 1939. Write for complete, technically detailed catalogs.

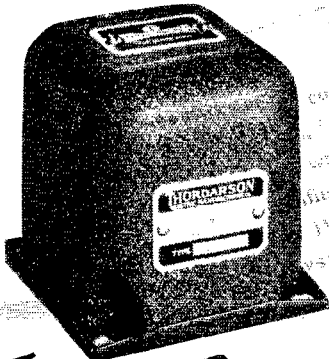

Transformer Specialists

THORDARSON Since 1895
CHICAGO, U. S. A.

Station Activities



NEW ENGLAND DIVISION

CONNECTICUT—SCM, Frederick Ellis, Jr., W1CTI —AW leads off by making B.P.L. on deliveries. UE announces the arrival of Bruce Thomas, July 14th. Congratulations! KKS has been riding around on his chariot, license plate 73, reporting some of the gang. 31VO-LLOC and the gang report from the U.S.S. *Semmes*. GB is active on 3.5 Mc. TD runs R.R. Net tests from GB and TD. CJD has been on 7138 kc. most of the time since June 1st. KQY reported direct by radio from GB. EFW is active in N.C.R. work, recruiting and bringing unit activity up to new levels required by the Navy Dept. KSJ was appointed O.R.S. MGW applied for O.R.S. CNU, CBA engineer and constructor, has installed a new filter condenser and says look for CBA on 3.5 Mc. most any time now. The Nutmeg Net will reopen for business, September 3rd, on 3640 kc. See you all there at 6:45 P.M. MEC is on 7 Mc. and hooking into the Philippine Express Net.

Traffic: W1AW 402 KKS 89 GB 23 TD 15 CSY 6 CJD-CTI 4 JTD-KQY 2 JPE 2 MEC 45 ITI (WLQG 34).

MAINE—SCM, H. W. Castner, W1HIE—I received a fine letter from K6QYI thanking the Maine boys for the help, especially LOZ. LVJ works 1.75 Mc. from Bangor on week-ends. LIP has been on 14-Mc. 'phone. VF has been maintaining daily schedules with BWR. Your S.C.M. has received an Honorary Membership in the Waterville Amateur Radio Club, and it's a real honor to be associated with these boys. The club is growing fast with new members coming in and, through Jap and Jack, the emergency set-up is certainly rounding into shape. I hope everyone will follow the Official Broadcasts from W1AW, or any other Official Broadcast Stations, as changes and new regulations are flying around thick and fast. There is a great need for operators in the various services, and there is going to be a job for almost anyone who can handle a soldering iron or copy code.

Traffic: W1HSE 3.

EASTERN MASSACHUSETTS—SCM, Frank L. Baker, Jr., W1ALP—LNN has new rig on 3.5 and 7 Mc. and has a weekly schedule with 2USA. HUV is still doing Observing work on 5 bands. MDN is building e.c.o. and is on 1.75 Mc. AAL can shift bands on 3.5, 7, 14 Mc. in one minute. LMO had to change his shack into a nursery; needs Nevada and Utah for W.A.S. DJ is on 56 Mc. on vacation at Wellfleet. KXU applied for O.R.S. and has new QTH. IN took part in his first F.D. and is on 7 Mc. MKN is now O.R.S. and has new power supply with 150 watts on 3.5 Mc. Welcome to new 15-year-old ham MTV; he has worked 31 states in one month. MJK and MQO are looking for more talent for 28 Mc. LTC is on 112-Mc. portable. LMB is back on 28 Mc. S1 is coming back on 28 Mc. New officers of M.V.A.R.C.: pres., IGO; vice-pres, LEA; secy., JJE; treas., HXE; news editor, JJE; asst news editor, Joe Remick. JXU is now O.P.S. and busy in National Guard. East Mass. Net opens on Sept. 3rd on 3.5 Mc. JYJ is looking for new members. Anyone interested, please write him. We all wish Charlie McKeen, DEK, a speedy recovery; he is very ill at the Middlesex County Sanitorium, Trapello Rd., Waltham. Let's all send him a card to help pass the time for him. GAG has c.w. rig for 7-Mc. and 28-Mc. Johnson Q. BDU made B.P.L. this month. JCK says A.A.R.S. nets are on with skeleton force through summer. LGH is winding a generator for emergency power. KH had a grand time at Farmers Net picnic at Laconia, N. H. BB is keeping schedule with ATK. Parkway Radio Club had a swell time at Bow Lake on F.D. MMK is observing quiet hours. AAR went up to Mt. Wachusett and met gang of 112-Mc. boys. HQH at Falmouth is active on 3.5 Mc. A lot of the hams think it is necessary to have emergency power and rigs to join the Emergency Corps. This is not so. There are two divisions, Emergency-Powered Stations and Supporting Stations. Write for application or information to HXE, or your County Coordinators, Bristol County, JYJ; Essex, QW; Middlesex, BZQ; Norfolk, JKR; Plymouth, LBY; Suffolk, JCK. We need a Coordinator for Barnstable County. What say, some of you hams down on Cape Cod? If you are a League member, you are eligible to be the E.C. for your town. Do you know if your town is covered in case of an emergency? If not, how about it? JJE now has 3rd

class 'phone ticket. LBH is still building a rig. LEA is now W.A.S., and is after Class A. LGG's new Jr. op. keeps him busy. Lowell Radio Operators Club went out on F.D., and also M.V.A.R.C. minus the cows and bulls. Hi. HUP is on 28 Mc. and is E.C. for Weston.

Traffic: W1BDU 281 EPE 68 (WLGS 16) LMO 50 EMG 48 AAR 45 JCK 45 (WLGW 24) AAL-LWH 40 LNN 37 KH 23 LGH 15 HWE 9 KTE 5 KXU 3 BB 2 KCQ 1. (May-June: W1JSM 75.) (May-July: W1KZT 33.)

WESTERN MASSACHUSETTS—SCM, William J. Barrett, W1JAH—AJ is still looking for Nev. and N.M. for the well-known reason. He had nice visit from CBN after lapse of eight years. IOR is keeping cool rag-chewing. Chet reports that BKQ had 13 operators in the F.D. The club is also redecorating its quarters. KRX visited HQO while on vacation. He reports LNF now on 3.5 Mc. GZL was visited by 2UH, 2KNB and LEP among others. Les reports a growth in 112-Mc. activity. BNL is rebuilding his portable and also new F.M. transmitter. LLY resigns as E.C. in order to take a year of active duty with Naval Reserve. COI, KFF, IJV and JAH have been conducting tests on 112 Mc. as part of comprehensive emergency plan for town of Adams. How about a card, gang?

Traffic: W1AJ 15 JAH 15 (WLGH 12) IOR 12 BIV 11 (WLGH 8) KRX 10 BVR 4 (WLG 50) GXL 4.

NEW HAMPSHIRE—SCM, Carl B. Evans, W1BFT-DMD—FLASH!!! The 7th Annual N. H. State Hamfest will be held at the Hotel Carpenter, Manchester, on Saturday, September 21, 1940. Keep the date in mind; we'll be seeing you there. According to late dope just received, JK operating at Exeter has contacted COO/1 on top of Mt. Washington on 225 Mc., which is a record of which to be proud. We are glad to see these N. H. u.l.f. men leading the field. The air-line distance is approximately 90 miles. FB, OM's. KTV has confined his activities to 28 Mc. IUI and LSN are still active on 56 Mc., the latter working two W9's recently when the band opened up. IVU has installed his rotary beam at new QTH and is all set for DX (?) on 14-Mc. 'phone. MUW is new ham in Manchester, and a YL at that!! FB!! EDN is now working for BFT in Concord. JNC is active on 56 Mc. and has knocked off a few W9's on that band. APQ has a new Meissner Signal Shifter. APK is building an F.M. receiver. EAL is on 4- and 14-Mc. 'phone with new Class A ticket. EAY is back on 3.5 Mc. after a long lay-off. AFD has taken unto himself an XYL. Congrats, Roy. JDV is sporting a new DM-36 expander and is working plenty of DX on 56 Mc. AED is rebuilding and getting set for the fall season.

Traffic: W1KIN 53 DMD 1.

RHODE ISLAND—SCM, Clayton C. Gordon, W1HRC—Walter Tedford of the Westerly Radio Association received his Class B with W1MVL for a call after waiting eight weeks. MOK is on with a new 35T final on 14, 7 and 3.5 Mc. The P.R.A. had a hot dog roast at Sunset Point in Lincoln Woods, July 16th, which was well attended by the boys and girls, including whole families with chilluns and everything. JXA brought along a watermelon and found himself very popular. JXA's daughter proved Girl Scout training by lighting fire without paper. GTN took pitchers of whole gang.

Traffic: W1EOF 5 HRC 3.

VERMONT—SCM, Clifton G. Parker, W1EJG—QQ is now operating on 3.5 Mc. DQK reports fine short-skip on 28 Mc. during June, and visits from FJO, BJP, MKM and CGX. AVP has new Stancor rig for 28 and 14 Mc. in addition to former outfit. St. Johnsbury Amateur Radio Club with three operators from Lamolle Valley Net participated as a unit in National Defense Day observance at St. Johnsbury on July 7th. MKM and XYL, and CGX visited many amateurs throughout entire Section while on vacation trip along with ND and family. CBW and family are spending summer in camp at Joe's Pond, Danville. GAE visited BNS and KJG. KUY is moving to Barre. MCQ is still at Veteran's Hospital at White River Junction and reported to be improving steadily. AEA is doing some work on 1.75-Mc. 'phone. KJR reports FB results with new antenna installation. Vt. Traffic Net will resume regular schedule on September 3rd, daily except Sunday, 8:00 P.M. prevailing time, on 3860 kc.

Traffic: W1AVP 8 KJG 7.

HUDSON DIVISION

EASTERN NEW YORK—SCM, Robert E. Haight, W2LU—ISQ reports nice traffic total with good schedules in all directions. KWG is pounding lots of brass.

MHW reports KWG and LMP visitors at his shack. MIY is heard on 3518, 3565, 3588 and 3742 kcs. JRG and HJM just eat up the air with their rag-chews. LEI reports Field Day activities great success and great time had by all. KFB reports new rig in 32-inch relay rack, getting out FB. MZR makes initial report. E.N.Y. welcomes him. He worked K6DFE on 7126 kc. KW of Radio Hill is erecting two 130-foot towers! HXQ reports fine results on Field Day, using call EOA/2. NDS, new ham in New Rochelle, is operating on 1864, 3516 and 7031 kc. LU wants recruits for Naval Communication Reserve. Every amateur with a license who is physically fit should not fail to offer his service to his government. The age limits for various ratings are now 17 to 50 years. What say you hams and ex-service men? We need you. Contact your S.C.M. LOR is building a new 60-watt 'phone-c.w. job.

Traffic: W2ISQ 149 KWG 115 MHW 112 MIY 88 JRG 16 LEI 15 LOR 12.

NORTHERN NEW JERSEY — SCM, Joseph P. Jessup, W2GVZ — Ass't S.C.M. in Charge of Emergency Coordination, Les Bagley, W2JMX. R.M.'s: 2BZJ, 2CGG, 2GVZ. P.A.M.: 2HNP. Section Net Frequency: 3630 kcs. (Net closed until Labor Day.) New appointment: O.P.S. KXT. KTR is on 112-Mc. 'phone. JIY and MNT applied for O.R.S. CQD applied for O.P.S. KXT sends Official Broadcasts on 1877-kc. 'phone at 7 P.M. during the summer. JUC and LXI joined A.A.R.S. The Woodbridge Amateur Radio Emergency Corps ran three rigs simultaneously with 21 operators in F.D., and gave all the emergency equipment of the whole gang a tryout under fire, by constantly substituting receivers, transmitters and power supplies. The success of the test was principally due to MEO, IGN, KZG, AUL, FUV, FUP, HDA and the E.C. GKX, JMX and LOP were in F.D. for a while and then visited the Plainfield and U.C.A.R.A. groups. U.C.A.R.A. and A.P.R.A. put in an all-night session at the lookout tower on Watchung Reservation. ILE picked a F.D. location completely surrounded by swamps. GT, GVZ and ZA took part in the DX C.C. QSO party. KHA placed third for the country in an A.A.R.S. QSO party. The Jersey Shore Amateur Radio Association and the Tri-Country Radio Association stand right up near the top in F.D. results. Congrats to both groups. New A.E.C. registrations: BPV, BQW, HMA, KQA, LSH, LYV and MPA. MXX applied for O.P.S. LOP and MHU chatted by auto horn during F.D., and KEY, who lived nearby, came romping through the bushes to join in. GVZ received a QSL from VU7BR after a year's effort. JUC is contemplating the construction of an e.c.o. and a mast. NCY, new ham in Dumont, is working 7 Mc. with a five-watter and SW3. KTR has been building a new rig for five months at the rate of one hour per month. MAX is rebuilding the heap to incorporate some improvements, MRJ wants O.R.S. HTX graduated from Cornell and is now with WOR. HNP is rebuilding. 3GRJ plans to marry and move to Orange in Sept. Contrary to unfounded rumors in S.N.J. notes and O.R.S.-O.P.S. bulletins, GVZ did not umpire the ball game at Trenton because he was away on vacation and knew nothing about it. 3CCO will explain — if he can. Hi. GYY is an ex-spark addict. The OW at MBO will feed any ham that brings his own pork chops to their QTH. BCC reports that she broils them to a turn. LMN received A-1 Operator Certificate. Congrats. GEL steps out with 10 watts 'phone and c.w. GJC raised antenna a bit and gets poorer results! GJD is returning to the air on 112 Mc. IYQ had FB time on F.D. along with IGT, JFB, JSE and KMK. MKW is rebuilding to a pair of 809's. KHA is off the air installing the equipment which he won in the A.A.R.S. contest. IYQ joined F.T.S.

Traffic: W2MNT 89 GVZ 50 (WLNI 33) LMN 48 (WLNX 52) KHA 47 HXI 38 ILE 27 MAX 25 LDB 24 IYQ 21 HNP-JUU 13 JIY 7 CJX 6 LXI 4 BZJ 2. (May-June: W2CGG 82 JDC 69 LMN 61 (WLNX 36) HGO 47 DYO 44 LDB 14.)

NEW YORK CITY AND LONG ISLAND — SCM, E. L. Baunach, W2AZV — VG, LYC, AYJ and BWC are now O.R.S. INF is out for O.R.S. and MIO for O.B.S. DBQ is one of the O.O.'s who have really high ratings in the A.R.R.L. frequency measuring tests. It was reported in last month's QST that CKQ and PL were operators of USA. CKQ wants to make it known that they are the custodians of the station. MZB is a new station in Islip. AES is a summer resident in Seaford, operating on 112 Mc. HHX from West Orange, N. J., is making his permanent residence with INF. AXZ is joining the regular U. S. Army Signal Corps. JGC spent the month of July at C.M.T.C. at Plattsburg,

N. Y. PF, with the first Army Maneuvers, is doing considerable experimenting with A.M. and F.M. on the ultra highs. CIT, LID and AJM are cruising with the N.C.R. JHB is op. at Burlington, Vt., airport. HNJ is breaking in his kid brother to be an operator. ELK is now located at 3034 Albany Crescent, N. Y. C., with his new XYL. LYC is studying for Class "A" exams. HBO reports that BVE moved to Baldwin, L. I. LID says that the "Nitwits" on 1807 have plenty of fun rag-chewing. KYV is experimenting. PL spends all of his operating time at USA. JBL had an FB time operating rigs at the W.F. LVN operates on 7184 kc. AZV is operating on 1.75-Mc. c.w. On July 7th DOG did some FB relaying for Relief Wings, Inc., handling their traffic to Greenport for a private airplane competition. EC is on 7260 kc. while he is rebuilding for the winter season. EYS is handling traffic on 7055 kc. HGO schedules MRV/1 at camp in Bridgeton, Me. KI carried out his schedule with 3BWT during the summer. LBI gave up his schedules for N.C.R. work. KDC is rebuilding 28-Mc. mobile rig to 112-Mc. job. LXC would like schedules with stations outside of the 2nd district to see what he can do with 3 watts input on 112 Mc. IXQ is going strong on 1.75-Mc. 'phone. Mr. M. Stember of the American Legion of N. Y. C. is desirous that all members of the Legion who have amateur stations in N. Y. State to get in touch with him.

Traffic: W2SC 608 USA 1182 LPJ 361 LZR 331 PL 217 KI 115 DBQ 115 AZV 99 LR 56 ITX 48 AXZ 31 KDC 25 PF 23 MT 22 CIT 12 AA 10 BGO 9 ADW 7 KYV-AEU-AZM 6 LYC-IGK-AVS 5 INF-LBI-IRC 4 ELK-EC-BYL-HNJ 3 JBL-DOG-EYS 2 HGO-CET-CHK-DLR-LWE-CTN 1 WLNM 87.

ATLANTIC DIVISION

EASTERN PENNSYLVANIA — SCM, Jerry Mathis, W3BES — We need more A.A.R.S. in the Eastern Penna. area, especially Phila. For information, contact 3AOC or 3EDC. — 3AOC. Recuperating from Field Day. — 3BIL. Seventeen members of the Lancaster Radio Transmitting Society operated three transmitters on its first Field Day. — 3DRO. The rebuilding "bug" bit again; this time I hope to tackle the homebuilt superhet problem. — 3EEW. Vacationing and rebuilding. — 3GDI. Worked KG6MV and received card from CR6AF; nearing Century Club. — 3GHD. Have been rebuilding. — 3GKR. The new rig is nearing completion. — 3GRF. 3GYK reports: "Field Day was super. 3IPZ is back from Maine and is raring to go. 3HRV is winding coils for his 814 to try 1.75 Mc. 3HRG is trying to be the one to get a Class B linear working, using 812's on 1.75 Mc. CQ-FD de 3QV/3-3HFE. Received QSL from CR6AF-3HTF. Had a swell time on Field Day after generator trouble was cured at 3CDY/3-3HZK. Putting rig in shape for next winter and have a 3.5 Mc. Zepp 50 feet high. — 3IAY. New Jr. opr. arrived June 23th, and the QRM is awful! Now you see why the QTA schedules. — 3QP. 3EU and your S.C.M. are competing to see who can move more often. The painters dismantled the antennas of 8GV. 8UQM will increase power. 3FRY visited 9VKF in Minnesota during the O.R.S. party, so he loaned his HRO to 3GHM for the event. 3BD met many of his old friends at the Selingsgrove Hamfest. 3AGV visited 3HTG in Atlantic City (the DX men know these lads). 3AMD received the Western Union Public Service Certificate. Congratulations! 3HQE received his long overdue QSL card from VU7BR. The new portable regulations have forced the Main Line Radio Club to hold their weekly transmitter hunts on Sunday mornings. 3CGM hides the small vibrapack operated transmitter just after daybreak. The Marine Corps Reserve has a very attractive proposition for able-bodied radio amateurs of the Phila. area. For more information you are invited to attend one of the weekly drills, Tuesday evenings, at the Marine Barracks No. 2, League Island Navy Yard, or contact Sgt. Robert Vernon, Navy Y.M.C.A., between the hours of 3:00 and 4:30 P.M. daily except Sunday.

Traffic: W3AOC 7 (WLQJ 49) AQN 5 BES 1 HRO 5 EEW 33 GHD 38 GKR 1 GKO 47 HRD 31 DRS 224 HTF 7 HXA 2 HZK 44 IAY 4 QP 404 RR 8 8ASW 32 EU 12 OML 5 UQM 1.

MARYLAND-DELAWARE-DISTRICT OF COLUMBIA — SCM, Hermann E. Hobbs; Acting SCM, Ep Darne, W3BWT, W3CIZ; Chief R.M. and Acting S.C.M.: 3BWT. R.M.'s: 3CXL and 3CDQ. Regional Coordinator: 3ZD. BWT is keeping regular schedules throughout the summer

(Continued on page 78)

ABBOTT—MRT-3

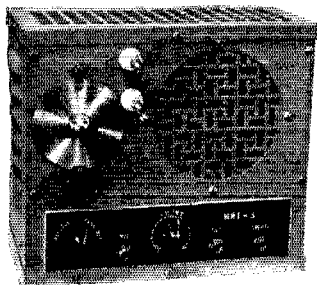

2½ Meter
Hi-Power
Mobile
Transceiver
20 Watts Input
Price
\$47.00 List
Less — 40%
to Amateurs

The unit you need for your car operates from car battery and vibrator power supply.

Real transmitting tube Hytron HY-75 used in the R.F.

EXTREMELY COMPACT

Size 9" long — 8" high — 4" deep. Self contained PM dynamic speaker.

FIXED STATION OPERATION

AC power supply is available for fixed station operation from 110 volts A.C.

NOTE: Portable and mobile operation on 2½ meters is permitted by the F. C. C.

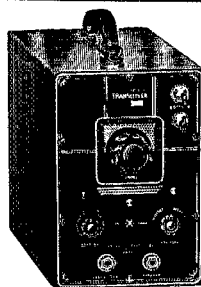

DK-2
2½ METER
BATTERY TRANSCIVER
Ideal for summer portable operation
— simple and convenient.
List Price \$27.50
LESS TUBES AND BATTERIES
40% Discount to Amateurs

GENERAL: The DK-2 is a completely self-contained 112 mc. radio-telephone transmitter and receiver, for use in your car, plane, boat, or while being carried, for portable work. It is very simple to operate. The working

range is between 2 to 30 miles depending on the location. Astonishing results have been obtained.

BATTERY REQUIREMENTS: Three 45 volt B batteries like Burgess 5308; and four No. 6 dry cells, or two Burgess 2F2H batteries.

SEE IT AT YOUR FAVORITE DEALER

Write for bulletin

ABBOTT INSTRUMENT, INC.

51 Vesey Street

New York City

RADIO OPERATORS' LICENSE GUIDE

Here's a new Guide Book that contains over 1200 questions and answers which will help you pass the new six element examinations for a commercial radio operator's license. It correctly answers all questions

contained in the study guide that was recently released by the Federal Communications Commission for the use of those proposing to take its examination. It will not only see you through your examination, but will also serve as a valuable future reference book. \$3.00 postpaid. Refunded if not satisfactory. Send check or money order.



ONLY \$3.00
Postpaid

WAYNE MILLER, SUITE 200
Engineering Bldg. ■ Chicago, Illinois

Wisconsin State Convention

(Continued from page 66)

obtainable with f.m. transmission. During the afternoon two crackerjack lectures were given, one an instructive demonstration of various types of light waves by Charles C. Kruse of the Milwaukee Vocational School, and the other by Walther Richter, electronics engineer, designed to facilitate the amateurs' understanding of vacuum tube operation by a novel mechanical analogy. After-dinner speeches were taboo at the banquet, and after the prizes were distributed the second Wisconsin State Convention had passed into history.

Catalogs and Pamphlets

The following catalogs and pamphlets are available to amateurs upon requests addressed to the manufacturer or his local representative:

Kenrad Tube & Lamp Corp., Owensboro, Ky.

An 8-page booklet listing the essential characteristics of Kenrad receiving tubes. Two pages of base-connection diagrams and a page of outline drawings with dimensions are included.

RCA Mfg. Co., Inc., Harrison, N. J.

A new 50-page "Ham Guide" may be obtained from your local RCA transmitting-tube distributor or by sending 15 cents to the above address. In its pages are given authoritative technical data on RCA transmitting tubes, proved circuits for utilizing them to best advantage and helpful information on the design and operation of amateur transmitters. Detailed descriptions, with illustrations, for constructing two complete amateur transmitters are shown.

Electronic Laboratories, Inc., Indianapolis, Ind.

Two circulars illustrating a complete line of standard and custom-built vibrator-type d.c.-a.c. converters, operating from d.c. voltages from 6 to 220, delivering powers up to 500 watts at 110 volts, 60 cycles a.c.

Standard Transformer Corp., 1500 N. Halstead St., Chicago, Ill.

A new *Service Guide* providing tube and transformer data on 4300 radio receivers of 70 manufacturers. Of particular interest to the amateur is the section devoted to circuits for testing equipment.

Strays

New QSL Album

Gordon Specialties Co. of Chicago, Ill., is now producing a well-bound album made especially for the preservation of amateur QSL cards. It is furnished with 50 loose-leaf pages of gray cover stock which will accommodate 400 standard-size QSL cards. The album is bound in red grained Morocco with a gold-embossed cover. Gold call letters are furnished with the album to fit in the space provided on the cover.

IF YOU WANT
GKO 474 RAD 51 LRS 224

If it's Results You Want—



\$149⁵⁰ Complete with 14 Tubes,
External Dynamic Speaker
to Match and Crystal Filter

The New HOWARD "490" Gives You "Plus" Performance all the Way!

- 14 Tubes
- 540 KC—43 MC
- 2 Stages R.F. Preselection
- Calibrated Band Spread
- Air-Tuned I.F. Transformers
- Variable I.F. Selectivity
- Temperature Compensated Oscillator
- Split Stator Ceramic Insulated Tuning Condensers
- Variable Fidelity Audio
- 8 Watts Push Pull Output
- Automatic Noise Limiter

A Communication Receiver that could truly be termed "tops" in every respect, the HOWARD Model 490 is the result of over a year's engineering and development. New standards of performance were set and are now available for the first time outside of laboratory equipment.

You will have—sensitivity that never knows "crowding"—selectivity that may be varied from crystal CW to wide band high fidelity—an audio system with flat response of 30 to 10,000 cycles—high or low frequency cutoff of a 1600 cycle peak—and all reproduced through a dynamic speaker having the best in both high and low frequency response.

Write the factory for complete technical manual on the great 490 and see your distributor for a demonstration.

HOWARD RADIO COMPANY

1731-35 Belmont Ave., Chicago—Cable Address HOWARDCO, U.S.A.

Engineered and Built by America's Oldest Radio Manufacturer

*There's
MORE OF
Everything*

in the

New HOWARD "490"

(Continued from page 69)

season. FPQ was with ZD at Skyline, Va., on Field Day; made 50 contacts with portable equipment. IMN is back on the air. EZN is on nightly for QSO's on 7 Mc. GAK is back on with new transmitter and antenna. The Washington Radio Club held its annual picnic, July 27th, at the farm of W3EEN. All amateurs of the Washington area were invited. The usual picnic festivities, games and general good fun were thoroughly enjoyed by all in attendance. In addition to the picnic, a booth was set up for taking photos as required by the new F.C.C. regulations. A representative from the F.C.C. was present to take fingerprints, and a Notary for the required oath. One had only to bring along his F.C.C. sheets and his birth certificate, or other proof, and the rest was attended to, for him. The Washington Radio Club held its annual Field Day get-together at Braddock Heights, Md. Nice weather and a swell time was had by all present; same dates as A.R.R.L. Field Day. The Section regrets the loss of one of its best traffic pushers, Sgt. George Jorgenson, W3BND, of Fort Hoyle, Md. Our Pal George has been transferred to Columbia, S. C. He hopes to contact all the gang from there soon as he gets on the air.

Traffic: W3BWT 515 CIZ 242 CXL 77 (WLM 1873) ECP 23 GYQ 25 FPQ 3.

SOUTHERN NEW JERSEY — SCM, Lester H. Allen, W3CCO — Ass't SCM and A.A.R.S. Liaison R.M., Ed G. Raser; 3ZL N.C.R. Liaison R.M., Ed B. Kerr, W3CCC. Regional Coördinator in charge of Emergency Coördination, Ted Toretti, W3BAQ. R.M.'s: 3BEI, 3BYR, 3EUH. P.A.M.: 3GNU. Section Net frequencies: O.R.S. 3700 kc., O.P.S. 1980 kc. 3ZI announces that the O.R.S. Net will get under way September 10th. This net is open for all O.R.S. appointees. You who are contemplating an O.R.S. appointment, send in your applications. The Official 'Phone Station Net, under the direction of Net Control Station W3EUH, will get under way September 9th. All Official 'Phone Stations are requested to join this net. Bill has some very outstanding stunts for the 'phone men to work on this year, and would like to see 100% attendance. ASQ is new O.B.S., and will be on daily at 10:15 p.m. OQ is quite busy checking the bands for harmonics, bad notes, overmodulation, etc. ABS has a new HQ120X receiver. GCU mentions that, effective Sept. 15th, all of his Official Broadcasts will be on 3700 kc. at 1 A.M. EST. AXU has moved; the new QTH: 2165 Pennington Road. BPT has a full kw. on the air these days. BAY is back on 14-Mc. 'phone. IFT has two new 50-foot towers. HRS is running 250 watts input to an 809, and claims it works FB. The Pitman boys welcome EKL back to S.N.J. ABS reports hearing several W5 stations on 56 Mc. during the last skip. ISZ has new 40-foot tower for his antenna. ITU is working 112 Mc. with a portable transceiver. FMR schedules with 9CAC twice daily. AID is still monitoring the bands in his Official Observer capacity. BAQ has appointed HW and ZI as Assistant Coördinators for Trenton. Ted wishes anyone in our Section who is interested in the Emergency Coördinator work to get in touch with him, as there is a lot of territory available for appointments. It is further requested that all members of the Section who have not signed up in the A.E.C. send in their applications at once so that we may get 100% representation. Five members of the Delaware Valley Radio Association recently installed three 112-Mc. transceivers at the Trenton Soap Box Derby, where communications were established between the start and finish lines, so that the Official timing could be accomplished in an easy manner. This set-up was highly successful and was highly commended by high-ranking officials of the city of Trenton and members of the American Businessmen's Clubs who were co-sponsors of the affair. The operators who took part were RAQ, CCO, IOK, ITU and ZI. Both Trenton radio clubs showed an increase in score in this year's Field Day contest; the Trenton Radio Society had a score of 3006, and the Delaware Valley Radio Ass'n tripled its score from last year with a collection of 5490 points. It has often been said that amateurs go to great lengths to carry on an experiment. IOK, not to be outdone, chartered a ferris wheel at a local carnival to try out his 112-Mc. transceiver; result: band dead! CFS added an oscilloscope to his equipment. GAF has his new rig perking FB on 1.75-Mc. 'phone. ACC reports working out swell on 14-Mc. 'phone. HVO schedules FXS twice weekly on the Y.L.R.L. Net. HEO has new modulators for the rig. HAZ increased power to 400 watts and enclosed the rig in a metal 6-foot cabinet. CCC needs the 5 hardest-to-get states for W.A.S. GRW has new receiver under construction. BWF built a new modulator using a

pair of T20's in Class B. The Delaware Valley Radio Ass'n of Trenton is now a 100% A.R.R.L. club with all of its members belonging to our League. This seems to be a good time for the balance of the clubs in our Section to follow suit and help out the League's membership campaign. GHR of Woodbury is active on 3.5 Mc. HTJ completed his small rig by putting it in a metal cabinet. Until next month, 73.

Traffic: W3FXN 257 OQ 135 EUH 75 HAZ 65 GRW 59 ZI 49 ARN-CCC-GCU 35 IFT 33 CCO 24 ATF 23 ABS 20 IOK 16 BWF 14 ITU 13 GNU 12 BAY 8 ISZ 4.

WESTERN NEW YORK — SCM, Fred Chichester, W8PLA — R.M.'s: 8BJO, 8CSF, 8DSS, 8FCG, P.A.M.'s: 8CGU, 8RVM, E.C.'s: 8FNT, 8GWY, 8RVM, 8SBV, 8SMH. Net frequency: 3720 kc. PCN has been monitoring the net frequency regularly. DZF became the father of a baby boy, June 27th. USF won a 7-Mc. crystal at the R.A.R.A. picnic, and is building a new rig with 6L6 final. He has been doing a swell job with a 53 crystal oscillator on 1.75 Mc. RGA is now using a pair of ten's in the final. RLI is now on 1.75-Mc. c.w. UYW is Rochester's newest ham. The YL of SGX is wearing a beautiful diamond ring. Congratulations, Roy. PAL is on 28-Mc. 'phone almost all the time. NYA is working 14 Mc. NYA, FAL and BHK, operating under BHK's call from a 2000-foot elevation, worked 19 stations during Field Day, using 15 watts. JIW has just worked KB6RWZ for his 86th country, using low power. DRY and RAR are finally on 3.9-Mc. 'phone. SMI is keeping three schedules during the summer. BWH, of Brasher Falls, is a new member of the St. Lawrence Net. The facilities of this net have been offered to the American Legion Posts and Red Cross Units, in the vicinity, for use in emergencies. The Buffalo Mike and Key Club announces a hamfest to be held Saturday, Oct. 5th, at the Hotel Buffalo. This is sponsored jointly by the Club and the Western New York Radio Council. There will be one speaker and floor show entertainment and prizes. Dinner will be served at 7 p.m. Tickets \$2.00 a person or \$3.50 per couple. The Mike and Key Club held a picnic at Emery Park ball field on July 20th, with the K.B.T. Club as guests. The K.B.T. Club has rented a cottage at Crystal Beach for swimming and amusement. Those present are NWH, NEL, NVJ, MQX, PMI. The K.B.T. Club and the Five-Meter Club held a ball game on July 4th, outcome unknown. NWH announces great success on Field Day. Four transmitters were operated on 14, 7, 3.9, 3.5 and 1.75 Mc. Two balloon antennas were lost after considerable use and much technical data was obtained. A total of 216 stations in all districts was worked for a score of 3132 points. Many local hams visited this elaborate set-up, and the experience gained this year will help the score next year. K.B.T. Club announces a joint picnic with the Five-Meter Club to be held Oct. 4th, at which time prizes for the 112-Mc. contest will be awarded. After the award K.B.T. will hold its first active meeting of the new season, and there will be election of officers. JTT and PCN have taken pictures of all Buffalo Army stations, to be printed in A.A.R.S. bulletins this fall. EKM has his 7-Mc. RK20-final rig installed in the Boy Scout troop headquarters in Buffalo. IIO has a new 300-watt cathode-modulated rig on 3995 kc. FNT, of Rochester, will soon be O.R.S. in the W.N.Y. Net. JTT visits PCN once a week, now that Roger is working in Buffalo. UBQ and UCO have built 112-Mc. rigs and are active on that band. PCN is endeavoring to establish a N.Y.C.R.R. Net. Anyone interested may write him at 20 Commonwealth, Buffalo. NEL has a new 7- and 3.5-Mc. rig. RRL is planning a 112-Mc. television transmitter and receiver, incorporating the latest developments. NVO had his appendix removed and is better than ever. OMD is building model operating race car and is inquiring for names of others interested in this hobby. R.A.R.A. held a basket picnic at QBP's cottage in Holland's Cove, July 28th.

Traffic: W8AQE 10 JIW 21 JTT 14 PCN 123 PLA 24 SMI 18 UNY 5.

ROANOKE DIVISION

NORTH CAROLINA — SCM, W. J. Wortman, W4GYB — In the hottest month of the year, and in what is generally considered the most slack operating time our traffic totals have taken a decided boost. I am more than thankful to the gang for reporting the results. DWB with an e.o.o. takes over the top place. ECH is working in the F.T.S. and getting plenty of traffic. Two new O.R.S., GIQ and GIV, both starting out with a bang. DSY schedules west coast each night. AKC passes along a nice bunch of

traffic. BMR took active duty with N.C.R. ERG made 64 contacts Field Day. ESB is chewing fat on 1.75 Mc. FSF and FUU have Class A. FKU is now in New York with National Underwriters. AAK is out again, but energy is low. Sure glad to know that you are better, Marty. FXU is operating WE this summer and doing a real good job. GQE is rebuilding. DLX is having fun playing his recording made in Asheville. Yu orta heard 9TJ and 4CEN talking over DX C.C. in Asheville. FUA has new Mims Squirter. EZZ and EFL have built a 30-watt portable a.c. or d.c. rig. GLQ is newly-married. Congrats. TJ writes us from Newport News, Va., saying that he is building battleships. New hams in Greensboro: GXA and GXB. APP is a deserted fellow on 1.75 Mc. BHA is in the process of settling down to married life. AGD is on 14-Mc. 'phone. MR tried the DX C.C. Club Round-up. Don't forget the next meeting of the Floating Club in Greensboro, first Sunday in September. Chief Op at 4NC has changed from OG to RA. AHP moved to new home. Don't die, gang, but 4NC is actually on 3.9-Mc. 'phone. The club gave a big party for all its new married members, and one or two prospects. If you missed the Asheville Hamfest you just ain't lived this year, so far as hamfests are concerned. Another swell time was had by all, and our hats are off again to the Asheville gang. 9AA put on a swell demonstration of his Lazy Man transmitter, the Comedy acts were good, the food fine, and DW and I didn't talk all day. Good luck, gang.

Traffic: W4DWB 206 BCH 159 GIQ 108 DSY 75 AKC 64 GIV 51 WE (op by FXU) 35 BMR 23 ERG 12 ESL 3 NC 2 ESB 1.

SOUTH CAROLINA — SCM, Ted Ferguson, W4BQE/ANG — GCH can be heard on 7 Mc. CQU, EZF and FNC took part in Field Day with the Greenville gang. DPN can be heard on 3.9-Mc. 'phone. EXJ is back on 1.75 Mc. BPD reports his new shack complete, and invites the gang to visit him. GMO has new 6F6-807 rig on the air. GB operates 7 Mc. GKD has new rig with 100TH final. CQG is on active duty with the Navy. ECG has returned to the air at last. ANK changed QTH. BZX moved to new QTH. FMZ is busy with Naval Reserve. FQ has been ordered to active duty. CE is Comm. Officer on U.S.S. *Breckenridge* at Charleston. FRY can be heard on 1.75-Mc. 'phone. GIT divides time between 3.9 and 1.75 Mc. GCW has 65 watts on 1.75-Mc. 'phone. EVU can be heard on 1.75-Mc. 'Phone Net. FRY spent some time at Myrtle Beach. E0Z is back on 1.75-Mc. 'phone. EXH of Lexington attended the Asheville fest. The Greenville Amateur Radio Club had a nice attendance at its Field Day event. The equipment was located atop Paris Mountain. They made around 80 contacts. The Palmetto Amateur Radio Club, Inc., of Columbia enjoyed the Field Day event which was held at Lake Murray. A grand time was had by all with around 80 contacts. The N.C.S. of the 1.75-Mc. 'Phone Net invites all 1.75-Mc. 'phone fellows to take part in this net. If interested, please contact BPD. 73. — Ted.

Traffic: W4GB 19 GCH 11 BPD 8 GFP 7 EHF 6 EXJ 2. VIRGINIA — SCM, Frank S. Anderson, Jr., W3GWQ — ICL has new Class A ticket and is on 14-Mc. 'phone; works 1.75 Mc. with small rig built in back of all-wave console. HWJ worked portable with special permission of F.C.C. for Hampton Regatta. IKV is building portable and also new rig with Eimac 35TG's in final; grinds crystals for a pastime. HAE has new Skywire 46 feet high; now running 100 to 250 watts. IUV uses a 6L6G on 3.5 and 7 Mc. with Sky Champion receiver. FBL is rebuilding the exciter for his 806's and, in the meantime, seems to be getting out with an HT6. EQQ is rebuilding with expectations of big things this fall. IVN is new ham at Abingdon. IPA wants O.P.S. HNX is very active as new P.A.M. AVR is active on 14-Mc. 'phone. EZL is on 3.9-Mc. 'phone when at home. BSY is very active on 3.9- and 14-Mc. 'phone. EXW is on 7 Mc. HBE is Trunk Line station for Va.

Traffic: W8HBB 132 HAE 80 HWJ 9 IUV 5. (May-June: W3GTS 31.)

WEST VIRGINIA — SCM, W. D. Tabler, W8OXO — Field Day activity in West Virginia reached a new peak on June 22nd and 23rd. We do not have detailed reports, but participants that we know of were the Bluefield and Wheeling clubs, and the Mountaineer A.R.A., operating respectively under 8HUK/8, BTV/8 and BOK/8. Congratulations are due to all of those who assisted in the preparations for and the actual F.D. tests. Noticeable this year was the number of young chaps, hopeful of licenses, who wholeheartedly entered into the real labor of conducting a big-scale Club Field Day. With such spirit, West Virginia can

safely look ahead to a future bunch of fine alert hams. UNE is spending his vacation at Waynesboro, Pa., and operating at 3IMH. 8UNH/3IMH and 8SIG are keeping the 3770-Kc. Net frequency active this summer. SIG visited NEU and other Fairmont hams for the first time — he's a fine chap. 2CTT/8, formerly an instructor at West Virginia Univ., has accepted a post with R.C.A. in New York. PZT has his Class A, and immediately put up in his shack one of HD's signs, "Silence — Genius at Work!" UIW has his radio-telephone first ticket. PZP moved from Pennsboro to Weston. UFT and QUB, of Indianapolis, visited Huntington hams. We nominate for the most cheerful and good-natured cuss Jim Keathley, 8RJG. LNR moved to Indiana. Sorry to see you go, Dick — best luck to you! KGT was transferred from the Beekley State Police Radio Station to the one at Charleston, and is hanging a new 3.5-Mc. doublet. CYV enlisted in the Navy. AFX visited the New York Fair and operated at 2USA. Jimmie, the 11-year-old junior op at OXO, spent the Field Day week-end with the M.A.R.A. group, and had a fine time, beside being a real help to the operating crew. Jimmie and MZD claim the prize for disposing of the most rations. New officers of the Dunbar Club: John Lair, pres.; TNM, vice-pres.; TOK, secy. and treas.; SES, publicity manager and code instructor; and LIL, activities manager. Ed Darne at 3BWT and Pat at 8HD are still conducting their ham forum. The M.A.R.A. regrettably reports the loss of one of its members, Vernon Ball, of Grafton, who was killed in a plane crash near Aurora. PQQ has stepped his total DX confirmations to 105. KWU, the newest reporter, has one of the Howard combination receiver jobs. LCN, TGH and PUA are active on 112 Mc. Directed by PZT, a most enjoyable picnic was held at Jackson's Mill on July 21st. Present were RCN, MIP, SES, PZP, MIS, RGP, OJI, TOK, NTV, PZT, RCU, QJS, MCJ, KCY, EP, KWI, KXC, SIG, NEU, LCD, AKH, UIW, HSA, GBF, OXO, URB, of Marietta, Ohio, Charley Handy, Harry Robinson, Red Rhodes, John Huffman and Jarvis Hinkle. The big event was the prize drawing for a kilowatt transformer donated by MZD, who was unable to be present on account of illness. The proud winner was Paul, SES. Everyone claimed to have had a fine time and plenty to eat. A few more occupations: IJK, electrical engineer at rayon plant; SLE and GWE, meter men for power company; LCN and RCN, radio supplies salesmen. See you next month — 73.

Traffic: W8OXO 43 GBF 23 DFC 2. (May-June: W8PSR 42.)

DELTA DIVISION

ARKANSAS — SCM, H. E. Velte, W5ABI — FWJ (ex-W9ZXW) pounds brass on 7 Mc. using 6L6 P.P. osc. 4DJS/5, Jonesboro, is on active N.C.R. duty at Naval Air Station, Pensacola, Fla. 5HAE works 3.9-Mc. 'phone with 135 watts, e.o.o. HMU operates at 3609 kc. with 50 watts; has new receiver, Sky Champion, HWO, who has been operating 1.75-Mc. 'phone portable from U. of A., will be at R.O.T.C. Camp this summer at Fort Leavenworth, Kans. HWS is running 400 watts on 7 Mc. ISA is operating on 7 Mc. this summer. ISI visited IHC while back in Jonesboro. FWJ was elected president of the Neark Amateur Radio Association to fill vacancy created when 4DJS/5 went to Navy duty. IHC uses 3611 kc. IW has FB 1.75-Mc. 'phone at Manila. GNV is on night trick at Kasp. IGM received O.R.S. and R.M. appointments and built low-power 'phone rig. FDW is about ready to go with new rig. IRY keeps himself busy on 7 Mc. and 1.75-Mc. 'phone. CIU has rebuilt and has FB 'phone rig. IUE is operating 1.75-Mc. 'phone in L.R., hailing from Dallas. Welcome, OM, ISH, after working with GED in the development of some low-power 'phone rigs, moved to Mo., and is operating portable W9. FOF is in Norfolk, Va., with Navy. 9AKA visited in L.R. with the ham club. FRV is operating back in North Little Rock after school in Fayetteville. JBU is XYL op. at Smackover. JAP is newcomer in Horatio on 1.75-Mc. 'phone. FPU is breaking through QRM nicely with good stiff 1.75-Mc. 'phone signal. Ex-DJQ joined the immortal ranks of "Silent Mikes," but will always be remembered by his multitude of friends over the country.

Traffic: W5GED 1:

RADIO TRAINING



PORT ARTHUR COLLEGE — not privately owned, not operated for profit, a college built and endowed by the late capitalist-philanthropist, John W. Gates — offers the most thorough practical Radio training in America. P. A. C. owns Radio Station KPAC, which is equipped with the very latest type 1000-Watt high fidelity RCA transmitter, operating on 1220 kc. with directional antenna system. The college is authorized to teach RCA texts. Additional equipment consists of the latest type Marine and Airways Transmitter installation complete; SOS Automatic Alarm; Marine Direction Finder, two-way Television Transmitter and Receiver; Trans-radio Press Receiving Equipment; laboratory facilities where every phase of practical radio assembly technique is taught. Students assemble composite transmitters, audio amplifiers, RF amplifiers, etc. The Radio training covers thoroughly Airways, Press, Announcing, Teletype, Typewriting, Laboratory and practical experience at KPAC transmitter, control room and studios. Announcing is an optional part of this training; nevertheless a number of students annually make successful announcers.

Port Arthur College pioneered the teaching of radio with its first classes in 1909, and for thirty-one years has maintained an active Employment Bureau that is successful in placing graduates in airways, broadcast and marine radio industries.

If interested in details about the Radio Course, write for Bulletin R

PORT ARTHUR COLLEGE
PORT ARTHUR (World-Known Port)
TEXAS

EASY TO LEARN CODE

It is easy and pleasant to learn the modern way — with an Instructograph Code Teacher. Ideal for the beginner or advanced student. ■ Many tapes available ranging from alphabet for beginners to typical messages on all subjects. Speed range 5 to 40 WPM. ■ Always ready, no QRM, beats having someone send to you.

FOR SALE OR RENT

STANDARD with 10 tapes and book of instructions, A.C. motor \$24.50
 With spring-wound motor \$18.50
 JUNIOR with 5 tapes and book of instructions (not rented) \$12.00
 RENTAL Standard with 10 tapes and book of instructions \$3.00 first month, \$2.25 each additional month. References or \$10 deposit required. All rental payments may be applied on the purchase price should you decide to buy the equipment.

Write for details today

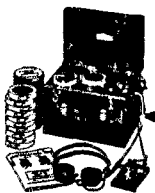

INSTRUCTOGRAPH COMPANY

Dept. O, 4701 Sheridan Road, Chicago, Illinois
 Representative for Canada:
 Radio College of Canada, 54 Bloor St. West, Toronto

QST Visits Riverhead and Rocky Point

(Continued from page 14)

the coupling link to a linear circuit connected between grid and cathode. Efficiencies of the order of 40% with outputs over 100 watts have been attained at 500 megacycles, which is something not to be lightly passed over!

A quick look at the commercial transmitters and our story is about over (after all, we had only one day at our disposal, and we had to keep moving!). The standard Rocky Point transmitter is the "20-40," so called because its nominal power output rating is 20 kw. at the higher-frequency end of its range (21,500 kc.) and 40 kw. at the low-frequency end (6600 kc.) These ratings are determined by the input-vs.-frequency ratings of the water-cooled tubes in the final stage rather than by other transmitter design considerations, incidentally. Basic design requirements were flexibility in changing from day to night frequencies, frequency stability, and the ability to key well at high speeds. To this end each transmitter is provided with two temperature-controlled crystal-oscillator units giving the desired day and night frequencies, and can be shifted from one frequency in the 6600-10,000-kc. region to another in the 10,000-21,500-kc. region by means of manually-operated switches which short out sections of inductances, or, in one or two cases, switch in entirely different coils. The r.f. end of the transmitter is divided into two sections, one, the exciter, a complete outfit in itself with an output of about a kilowatt, the other the power amplifier, connected to the exciter by transmission lines. The crystal oscillator operates in the 1500-3000-kc. region, and is followed by a low-power buffer amplifier. Three doublers follow the buffer, with 860's in the first two doubler stages and an 861 in the third. The final exciter stage has two 861's in push-pull. Keying takes place in the first doubler stage, where a pair of 211's in the keying unit shunt the plate supply to the 860, both doubler and keyer tubes being fed through a common dropping resistor from a 3000-volt plate supply. Under key-up conditions the 211's have positive grid bias, causing them to draw considerable plate current through the dropping resistor, with the result that the doubler plate voltage is too low to cause the tube to draw appreciable plate current. With key down, the 211's are biased to cut-off and the operating plate voltage is applied to the doubler. Succeeding stages are biased well beyond cut-off, so that any small amount of r.f. that may get through with the key up is not large enough to overcome the bias on following stages. This arrangement gives an excellent keying characteristic at high speeds.

The output amplifier uses four 207's in push-pull parallel, with plate voltages from 7500 at the high-frequency end to 12,000 at the low end. Considerable attention was given to obtaining electrical and mechanical symmetry in these circuits. Separate grid coils are used for the two frequency ranges, tuned by shorting turns with a

BUY NOW

Beat Advancing Prices!

SAVE MONEY

PRICES SLASHED TO CLOSE OUT

An accumulation of small lots of our famous
OIL FILLED, OIL IMPREGNATED
FILTER CONDENSERS

1000 V. DC, 1 mfd.

1500 V. DC, 1.5 mfd.

59c

69c

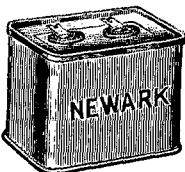

DC	Mfd.	Price
1000 v.	2	\$.89
1000 v.	4	1.10
1000 v.	6	1.25
1000 v.	8	1.45
1000 v.	9	1.65
1000 v.	18.3	2.15
1000 v.	27.5	2.65

DC	Mfd.	Price
1500 v.	2	\$.99
1500 v.	3	1.25
1500 v.	4.4	1.50
1500 v.	5	1.60
2000 v.	2	1.50
2000 v.	4.4	1.95
2000 v.	8	2.75
3000 v.	1	2.00
3000 v.	4	3.75

PRICES GUARANTEED THIS MONTH ONLY
Orders accepted subject to prior sale. Quantities are limited in some cases, so be sure to give second choice. These condensers are all brand new and FULLY GUARANTEED at rated voltages. **HURRY!**

ALL BEST KNOWN AMATEUR RECEIVERS

CAN BE PURCHASED ON NEWARK'S EASY PAYMENTS

- ★ Send 10% down payment with your order
- ★ Add 6% carrying charge to the balance
- ★ Divide into 12 monthly payments or less

Pick out any set you want and order it. Include your filter condensers, transformer or other supplies you need in the same order. **ENCLOSE ONLY 10% DOWN** (Minimum \$5). We ship direct from stock immediately upon credit approval. Order direct from this ad.

	Cash Price	Down Payment
Hallcrafters S 19 R	\$ 29.50	\$ 5.00
Hallcrafters S 20 R	49.50	5.00
National NC 44	49.50	5.00
Hallcrafters SX 24	81.50	8.15
Hallcrafters HI 6	99.00	9.90
Hallcrafters SX 25	99.50	9.95
National NC 101 X	129.00	12.90
RME 99	137.40	13.74
Hammarlund HQ 120 X	138.00	13.80
National NC 100 XA	142.50	14.25
RCA-AK 77	147.50	14.75
Hallcrafters SX 28	159.50	15.95
NATIONAL NRU	165.00	16.50
National HRO	205.50	20.55
Hallcrafters HT 9	237.35	23.73
Hammarlund Super Pro.	279.00	27.90

All sets complete ready to use. Shipped in brand new, original unopened factory cartons, from stock on hand.

YES... AS ALWAYS...

Newark will have the very latest in ham receivers as announced by leading manufacturers... on the same 6% Easy Credit Plan.

FREE BULLETIN

8 pages, illustrated. Just out, and full of Ham best suits, details of TIME PAYMENT PLAN. Every Ham a real savings well worth while.

YOUR CALL LETTERS IN GOLD... 10c

Put these big shadowed de-cakomanda letters on your Ham Shack door, auto win-down, etc. Nearly 2" high. Send dime for yours today. Be sure to give call letters.

How To Order

Send down payment with your order. We ship immediately upon credit approval. You pay balance plus 6% carrying charge in equal monthly payments of \$5 or more.

NEXT MONTH THEY'LL COST YOU 1/3 MORE!

HIGH VOLTAGE Power Transformers

Prices will advance 33%! Next month these transformers will cost \$3.45 or more!

600-0-600 V.—200 M.A.

\$2.59 NOW



Newark's larger volume of amateur business makes this unmatched value possible. Made by one of the largest transformer manufacturers. These husky transformers have a place in every Ham Rig. Guaranteed. As illustrated.

Choice of Two Filament Types
No. 4140—600-0-600 V.—200 M.A. Filaments: 7.5 V.C.T.-3A.—5.0 V.C.T.-3A.—2.5 V.C.T.-10 A. Wt. 8 1/2 lbs. \$2.59
No. 4240—600-0-600 V.—200 M.A. Filaments: 6.3 V.-4 A.—6.3 V.-3 A.—5.0 V.-3 A. Wt. 8 1/2 lbs. \$2.59

ANOTHER SALES LEADER!

Just the thing for the Osc. Power Supply, Speech Amplifier and many other services. Same style as illustrated above. Wt. 8 lbs. 350-0-350 Volts—150 M.A. 5 V.—3 A. 5 V.—3 A. 2.5 V.—3 A. 2.5 V.—7 A. No. 3004. \$1.69

NEW CATALOG OUT SEPT. 15

Write today for Special Bulletin and get ON THE LIST to receive this NEW catalog FREE from the Press.

NEWARK Electric Company

323 W. MADISON ST.
Dept. Q CHICAGO, ILL.



SOMETHING new in customer convenience. Harvey's new transmitter service. Our engineering staff will help you design your rig, supply you with standard prints and do the punching of your chassis. All this will be included in the cost of the parts.

Write for details of this new service, which offers you custom built commercial rigs at ham prices

FM TUNER

Complete, READY TO GO

Less power supply and tubes..... **\$12.95 net**
Includes punched chassis, all components and complete instructions.

MARION METERS

STILL A FEW LEFT

0-1 MA..... **\$2.85 net**
0-2500 Volts DC..... **2.85 net**
Shunts, multipliers and scale for converting to Volt-Ohm-Milliamperes..... **1.75 net**

2½ Meter Transceiver Kit

with drilled panel and chassis complete with recommended parts and tubes as described by Mr. Vernon Chambers. W1EQ in QST. Kit supplied completely assembled and ready for wiring..... **\$14.95 net**
Set of Batteries consisting of four Eveready long life Mini-Max B Batteries and one 6 Volt A Battery..... **\$4.72 net**

NEW Hallcrafters S-27

Ultra High Frequency 27-145 MC. Frequency Modulation-Amplitude Modulation..... **\$175.00 net**

POLYSTYRENE for UHF Coils

¼" rod, 12" long..... **\$.24 net**
¼" tubing, 12" long..... **.12 net**
¾" tubing, 12" long..... **.18 net**
1" tubing, 12" long..... **.59 net**
2-oz. coil, dope and cement..... **.29 net**
4-oz. size..... **.39 net**

W2IJJ W2LJA W2KWY W2IOP

OUR *Best* VALUE IS OUR RECORD OF LOYAL SERVICE

HARVEY

Radio Company of New York

103 WEST 43rd STREET • NEW YORK, N. Y.

CABLE ADDRESS: "HARADIO"

rotating disc for vernier adjustment. The plate tank is also tuned by the shorted-turn method; the two frequency ranges are obtained by switching in and out a fixed air condenser. There are some 30 of these transmitters in regular service; we hear them signing WIZ or WEM or some other familiar call in between the ham bands.

Other types of transmitters are used, too. Transmission line frequency control was developed at Rocky Point, first with open-wire lines which were given a thorough workout some years ago, then later with concentric lines. A concentric-line controlled transmitter, WHR (13,460 kc.) is shown in one of the photographs. The average stability of this transmitter is better than the average of the crystal-controlled sets, as determined by measurements over a considerable period of time. Some idea of the size of the line can be gathered from the picture; it is a quarter-wave long and shock-mounted to minimize vibration effects. The complete transmitter consists of the oscillator, a high-power job operated with light loading, and a single amplifier stage using water-cooled tubes. WHR is in regular use on one of the European circuits. Another line-controlled outfit, W2XS, operates regularly in experimental status on 31.6 megacycles. And, jumping to the other extreme, the aforementioned Alexanderson alternators are ready to put out on the long waves whenever needed. On these frequencies, high-power output with extremely low antenna resistance leads to tremendous antenna currents and voltages—so large that nearby wooden poles have to be wrapped with a grounded wire to keep them from burning up! The vicinity of one of the antenna towers is a good place not to be when the alternators are running.

All kinds of directive antennas are to be found at Rocky Point. Oddly enough, we saw no V's, although this is the home of the V antenna, but it just happens that none of them are near the transmitter buildings. There were plenty of the earlier echelon arrays, however, and a number of multielement broadside antennas. An antenna of the latter type is a veritable maze of wires, with antenna elements, transmission lines, and guys for keeping the elements in line forming a spider-web pattern against the sky. Beside them, the more flexible long-wire arrays look quite simple. The original broadside arrays used vertically-polarized elements, but they have since been changed over to horizontal elements because a simpler and more reliable mechanical structure resulted while the horizontal elements were equally, if not more, effective.

Our last visit on a memorable trip was to the relay broadcast transmitter, occupying its own building some distance from the main transmitter building. The 100-kw. amplifier in this set uses four water-cooled tubes of a new type which are now undergoing test, built into a unit with a great many unique electrical and mechanical features. Our remaining space doesn't permit going into more detail about this building, but we can't omit mentioning the portable modulator unit which can be pushed around the station and connected to any one of the several 10-kw. trans-

AMATEURS WANTED



PHOTO COURTESY BOEING AIRCRAFT COMPANY

Airline Radio Operators Are In Demand. If You Want A Steady Salaried Job Doing the Kind of Work That Is Now Your Hobby — Midland Training Can Prepare You

Amateur Radio Operators are wanted by the Aviation Division of Midland Radio and Television Schools, Inc., to train for steady, well-paid jobs as Airline Radio Operators. The demand for our graduates has exceeded the supply.

Near 100% Amateur Employment Record

During the past few years Midland has successfully trained and placed Amateurs from practically every district, establishing an amateur employment record very close to 100%, and a total employment record of approximately 97%. The experience gained through Amateur Radio Operating saves training time and tuition fees.

QST readers who are not Amateur Operators will find Midland training well adapted to their needs. Our plan puts you "on the air" as an Amateur previous to graduation as a competent commercial operator, eligible for Midland employment service.

Midland Airline training is supervised by instructors released to us by major airlines. Many interesting subjects in addition to radio are included. The success of Midland training is best proven by the fact that Midland graduates are employed by all major airlines and at more than 50 airports.

Investigate the advantages of Midland training. If you, yourself, are not interested, call this advertisement to the attention of some worthy man. If necessary, training need not interfere with present employment.

FOR COMPLETE INFORMATION, WIRE OR WRITE NORM SOUTHER, Vice-Pres., Dept. A.

MIDLAND RADIO AND TELEVISION SCHOOLS, INC.

Power and Light Building Kansas City, Mo.

MIDLAND GRADUATE "SPOT" FREQUENCY

Warm friendships, started at Midland, are kept alive over the Amateur "spot" frequency "CW" circuit, 7225 kc. This circuit is fostered by Midland Amateur Graduates, employed in all sections of the United States. The call "CQ-MR" usually results in an old-fashioned "ham fest" between brother grads.

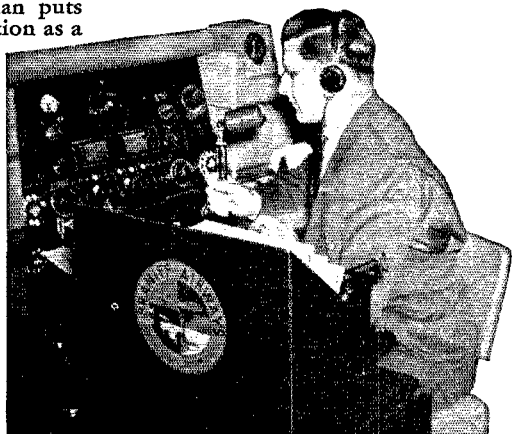

Midland Grad Elden Beasley, Senior Radio Operator, Braniff Airways, Dallas station, formerly W9PZA, now W5HMH, is but one of the many Amateur Operators who have turned their "hobby" into substantial pay checks through Midland Communications training. (Note modern equipment.)

ACROSS THE PAGE

We're talking about the book that has 576 pages, fully illustrated, covering every aspect of radio — as evidenced by the chapter headings:

INTRODUCTION

- 1 Story of Amateur Radio
- 2 Getting Started

PRINCIPLES AND DESIGN

- 3 Electrical and Radio Fundamentals
- 4 Reception of Radio Signals
- 5 Transmitter Design
- 6 Modulation

CONSTRUCTION AND ADJUSTMENT

- 7 Workshop Practice
- 8 Construction of Receivers
- 9 Tuning and Adjusting Receivers
- 10 Construction of Transmitters
- 11 Power Supply
- 12 Modulation Equipment
- 13 Complete Transmitters
- 14 Transmitter Adjustment
- 15 Keying and B.C.I. Elimination
- 16 Adjustment of Phone Transmitters
- 17 Measurements and Measuring Equipment
- 18 Emergency and Portable
- 19 Station Assembly
- 20 Tube Characteristics and Miscellaneous Data

ANTENNAS

- 21 Antenna Fundamentals
- 22 R.F. Transmission Lines
- 23 Long-Wire Antennas
- 24 Multi-Element Directive Systems
- 25 Antenna Construction

ULTRA-HIGH FREQUENCIES

- 26 Introduction to U.H.F.
- 27 Receiving Equipment for 28- and 56-MC.
- 28 28- and 56-Mc. Transmitters
- 29 112 MC. and higher
- 30 Antennas for the U.H.F.

OPERATING AND TRAFFIC HANDLING

- 31 Operating the Station
- 32 Regulations and Data

AMERICAN RADIO RELAY LEAGUE

West Hartford, Connecticut

mitters in the building. When the big amplifier is ready for service it too will be capable of being connected to any of the transmitters to serve as a linear amplifier when real "soup" is needed.

We should be ungrateful indeed if we did not, in closing this necessarily "high-spot" story of what we saw in a day crowded with new sights and new ideas, express our thanks to Dr. H. H. Beverage, Chief Research Engineer, for his kindness in arranging the visit for us, to Mr. H. O. Peterson for devoting practically an entire day to taking us to the various buildings (which meant a good deal of travelling) and patiently answering the questions which kept asking themselves, to Mr. C. W. Hansell for his efforts in making sure we saw what was there to be seen at the transmitter research laboratory and the transmitting stations, and to the many other staff members whom we met and whose courtesy in showing and explaining things was greatly appreciated.

New Transmitting Tube

RCA 825—Inductive-Output Amplifier

IN ANNOUNCING the new 825 inductive-output tube, RCA makes available to the amateur a valuable tool for the u.h.f. range. A general explanation of the operation of the tube is given elsewhere in this issue,¹ and Fig. 1 shows a cross-section view of the tube and a typical amplifier circuit. In the tube, the control grid is made small and mounted quite close to the cathode, to reduce the capacity transit-time effects. Grids Nos. 2, 3 and 4 are not grids in the usual sense but are cylinders through which the electron stream passes. Grids Nos. 2 and 3 serve as accelerating and focusing grids, while the No. 4 grid is so placed as to suppress the flow of secondary electrons emitted by the collector to other electrodes. A magnetic field furnished by the yoke and properly positioned with respect to the output tank circuit compensates for divergence in the electron stream caused by the r.f. electric field at the output gap.

The resonator output circuit is made in the form of a sphere with two opposite sides pushed in, as shown in the cross-sectional view. The inductive-output tube is placed through the center of this distorted copper sphere, and the magnetic yoke is simply a strap of magnetic material running up to the center of the circuit and joining two rings of magnetic material. A third ring, between the rings on the ends of the yoke, distorts the magnetic field and concentrates it at the necessary points. A solenoid winding is used to magnetize the yoke.

Power is coupled from the output circuit by a loop as shown. The d.c. input to the tube is the product of the collector voltage (measured between collector and cathode) and the collector current, as in the case of conventional tubes. The

¹ "QST Visits Riverhead and Rocky Point," QST, September, 1940.

*MORE THAN
60,000 COPIES
of the 1940 Edition of*
**THE
RADIO AMATEUR'S
HANDBOOK**
have been sold

Have YOU yours?

\$1.00

Buckram bound—\$2.50

Spanish Edition—\$1.50

\$1.25 OUTSIDE CONTINENTAL U. S. A.

American Radio Relay League
West Hartford, Connecticut

¡ATENCIÓN!

La Terminal mantiene existencias completas de todo lo que se relaciona con el ramo de radio: aparatos transmisores, receptores, sistemas de amplificación de la voz, etc., y dispone de excelentes facilidades para la exportación de esos productos.

Nos será sumamente grato tener la oportunidad de surtirlos de los productos de esta clase que necesiten.

La Terminal Radio Corporation es la casa proveedora de productos de radio más grande de Nueva York dedicada exclusivamente a la venta de equipos de radio.

Los invitamos a que nos consulten. Remitiremos catálogos a solicitud especial.

Dirija sus cartas a:
TERMINAL RADIO CORP.
 68 West 45th Street
 New York, N. Y., E. U. de A.

TERMINAL Radio Corp.

68 West 45th St. • 80 Cortlandt St.
 2 stores in NEW YORK CITY
 V.Anderbilt 6-5050 • Cable: TERM RADIO

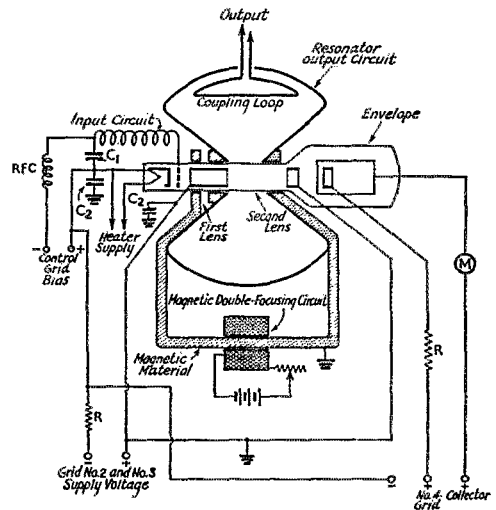

Fig. 1 — A cross-section view of the inductive-output tube, and a typical amplifier circuit.

- C₁ — Input tuning condenser.
- C₂ — R.f. by-pass condenser.
- R — Current-limiting resistor.
- RFC — R.f. choke.

power dissipated at the collector is the difference between the power input to the collector and the power coupled from the electron stream by the loaded output tank. Raising the collector voltage does not always raise the output or the efficiency, since it is necessary only that the collector voltage be high enough to collect the electrons that have been decelerated on their passage through the tank-circuit gap.

The tube is designed for use as a power amplifier at frequencies above 300 Mc., and in such use it is capable of delivering up to 35 watts output, depending on the bandwidth and the type of service. It can also be used as an oscillator or frequency multiplier. Its characteristics and maximum ratings follow:

Heater voltage.....	6.3 volts
Heater current.....	0.75 amperes
Transconductance.....	5500 μ mhos.
Interelectrode capacities	
Grid No. 1 to cathode.....	3.4 μ fd.
Grid No. 1 to Grid No. 2.....	1.7 μ fd.
Grid No. 2 to cathode.....	0.9 μ fd.
D.c. collector voltage.....	2000 max. volts
D.c. collector No. 4 voltage.....	1500 max. volts
D.c. grids No. 3 and No. 2 voltage.....	3600 max. volts
Collector input.....	100 max. watts
Typical operation, Class C telegraphy at 500 Mc.	
D.c. collector voltage.....	1500 volts
D.c. collector No. 4 voltage.....	800 volts
D.c. grids No. 3 and No. 2 voltage.....	3600 volts
D.c. grid No. 1 voltage	
From a fixed supply of.....	-40 volts
From a cathode resistor of.....	800 ohms
From a grid resistor of.....	18,000 ohms
Peak r.f. grid voltage.....	45 volts
D.c. collector current.....	45 ma.
D.c. grid No. 4 current.....	2 ma.
D.c. grid No. 3 current.....	0.5 ma.
D.c. grid No. 2 current.....	1 ma.
D.c. grid No. 1 current.....	2.3 ma.
Power output (approx.).....	35 watts

The focusing electromagnet is a double magnetic lens operated at approximately 1000 ampere turns.

Bootleg Catcher

Who says the F.C.C. isn't on the job? The little gimmick illustrated was devised and built in the office of Charles C. Kolster, Radio Inspector-in-Charge at Boston, and has been so successful that it is soon to become standard equipment of the F.C.C. Its particular usefulness is to lead an inspector to the right door of an

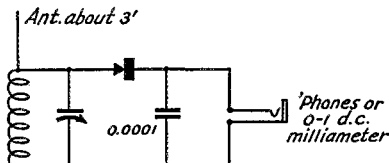

apartment house, or other congested locality, where a bootlegger is operating—after the general locality has been spotted with more sensitive apparatus.

With the 3-foot antenna dropped down a trouser leg, the little box is carried in hand while



watching the milliammeter; or 'phones may be worn. The pillbox on top is a fixed crystal detector. The one control is the tuning condenser. For the 56-Mc. band the condenser is 15 μ fd., while the self-supporting coil has $5\frac{1}{2}$ turns of $\frac{3}{4}$ -inch diameter.

Not so bad, eh?

Strays

While I was home from school for a holiday, I made several contacts from a friend's station among which was one with W9GUR. Upon returning to school, W9GUR answered my first CQ. I was 600 miles from where I contacted him before and using a different call. — W6IHZ.



Silence!

● You don't have to put up with background noises caused by refrigerators, oil burners, electric razors or other noise-producing appliances. Aerovox has a simple, effective, inexpensive cure for your troubles.

Seven different types of line filters take care of all standard kinds of radio-noise producers. And the Aerovox Interference Analyzer helps select the right filter and indicates the most effective installation.

Help yourself clean up background noises with these simple plug-in accessories. Help your BCL listeners clean up their troubles. Help the radio fraternity generally in its big battle against man-made static.

Ask for DATA...

Your local Aerovox jobber can show you this noise-killing line. Ask for copy of "Clear Reception" or write us direct.



RADIO

ENGINEERING, broadcasting, aviation and radio telegraphy and telephony, Morse telegraphy and railway accounting taught thoroughly. 48 weeks' engineering course, equivalent to three years of college radio work. School established 1874. All expenses low. Catalog free.

DODGE'S INSTITUTE, Day Street, Valparaiso, Indiana

LEARN CODE

the way you'll be using it
by **SOUND**



The best way to learn to read code is by listening to code. The best way to learn to send code is by hearing your own sending repeated back to you. With the new All-Electric Master Teleplex Code Teaching Machine, you learn code the natural, easy, fascinating way. Only instrument ever produced

which records your sending in visible dots and dashes — then SENDS BACK your own key work at any speed you desire. That's why practically every school teaching code uses TELEPLEX. We furnish complete course, lend you All-Electric Master Teleplex, give you personal instruction with a MONEY BACK GUARANTEE — all at a surprisingly low cost per month. Write today for FREE catalog Q. 9. No obligation.

‘‘HAM’’
SPECIAL

Standard Teleplex — a highly efficient code teacher using heavy specially prepared waxed paper tape, having two rows of perforations. Write for Free folder "Q.T.9".

TELEPLEX CO., 67-69 Park Place, New York
In Canada, Write

Canadian Electronic Institute, Toronto, Ontario

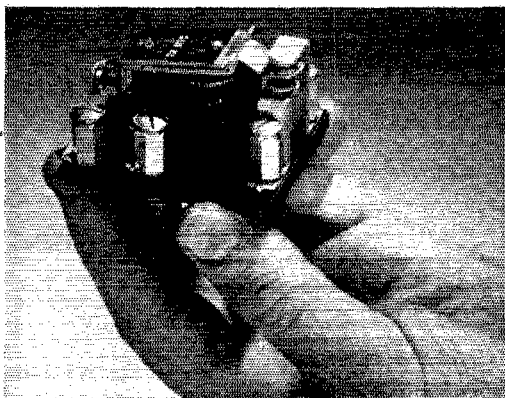

A NEW RELAY HUSKIER, COSTS LESS

The design of this new compact Ward Leonard single pole heavy duty relay is simplicity itself. It is sturdily built yet there is not an ounce of material in it that is not essential to efficient performance. Measures only $1\frac{7}{8}$ " x $2\frac{5}{8}$ ". Will control $\frac{3}{4}$ h.p. on 115-230 volts. Described in Bulletin 105.

WARD LEONARD ELECTRIC COMPANY

41 South Street, Mt. Vernon, N. Y.

MORE EFFICIENCY PER DOLLAR!... with these New 100-Watt Turrets

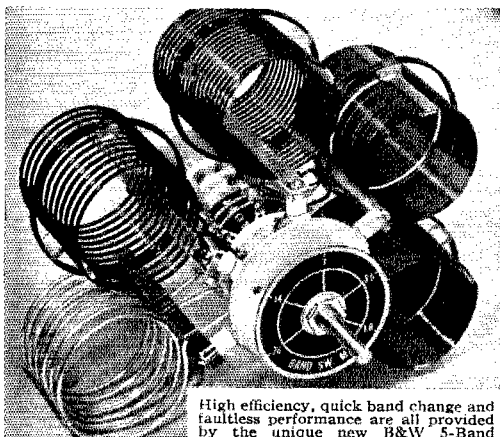

High efficiency, quick band change and faultless performance are all provided by the unique new B&W 5-Band Turrets. Moreover, the total cost of one of these turrets and suitable condensers is actually less than available.

Available center linked (Type BCL) or end linked (Type BEL), they are conservatively rated at 100 watts — conservatively priced at \$3.50 net. They provide fast, positive band switching on the 10 to 160 meter bands. (The same units are also available with coils of specific inductance values for commercial purposes.)

General specifications of BCL and BEL Turrets are given in our advertisement in August *QST*. See your jobber, or write, for more complete details.

BARKER & WILLIAMSON

Radio Manufacturing Engineers • ARDMORE, PENNSYLVANIA

What the League Is Doing

(Continued from page 28)

ready when you appear for examination. Take the fingerprint card with you; the F.C.C. inspector will make the impressions. Turn all the papers over to the inspector, who will attach them to your examination paper for transmittal to Washington. If you are a Class C applicant and have received your examination papers by mail, have your fingerprints taken by a law-enforcement agency such as your local police, and fill out the other forms and send everything along with your examination papers when you mail them in to Washington.

The required photograph, by the way, is of passport type, full-face, bareheaded, taken within the past year, not over $2\frac{1}{2}$ " by $2\frac{1}{2}$ " inches.

Some recent interpretations: (1) Despite the instructions that a birth certificate will be accepted only when the data had been recorded a short time after birth, a certificate in otherwise satisfactory form will now be accepted regardless of the date of first recording. (2) When birth certificates do not identify the amateur by name, he should also obtain an affidavit from a parent or any other relative in position to know the facts, identifying him as the child thus born. Sometimes Vital Statistics offices will accept such affidavit and then issue the certificate in the name of the applicant. (3) Naturalized citizens must answer the questionnaire fully but need not produce a birth certificate. Only thing wanted from them is accurate description of the naturalization certificate, in response to Question 6, plus the following certification by notary or other official who administers the oath, written either opposite his signature or separately:

"I certify that this individual's naturalization certificate is accurately described in the response to Question 6 and that I believe the individual appearing before me is the individual named therein."

NEW REGULATIONS

ON JULY 5th, F.C.C. adopted the following new rule governing amateurs:

12.156. *Obscenity, indecency, profanity.* No licensed radio operator or other person shall transmit communications containing obscene, indecent, or profane words, language, or meaning.

12.157. *False signals.* No licensed radio operator shall transmit false or deceptive signals or communications by radio, or any call letter or signal which has not been assigned by proper authority to the radio station he is operating.

12.158. *Unidentified communications.* No licensed radio operator shall transmit unidentified radio communications or signals.

12.159. *Interference.* No licensed radio operator shall willfully or maliciously interfere with or cause interference to any radio communication or signal.

12.160. *Damage to apparatus.* No licensed radio operator shall willfully damage, or cause or permit to be damaged, any radio apparatus or installation in any licensed radio station.

12.161. *Fraudulent licenses.* No licensed radio operator or other person shall obtain or attempt to obtain, or assist another to obtain or attempt to obtain, an operator license by fraudulent means.

These new rules go at the end of the amateur regulations as an addition to the section entitled "Special Conditions." They will be recognized as

nothing new, being requirements already contained in the Communications Act itself. However, they have not previously been the subject of Commission rules and the present action gives them additional importance in that additional penalties may now be assessed for their violation. Almost identical regulations were simultaneously adopted to govern commercial operators.

Automatic Tuning for the Amateur Transmitter

(Continued from page 31)

the movement of the master cable *F* causes a stop *L* to push the slider *E* to the right and thus turns the variable condenser to minimum capacity, which is the "neutral" position. While holding lever *K* in this position, the rotary cage can be turned to any one of the eleven available positions by rotating lever *Q*. When the desired position is selected lever *K* is released, which permits the slider *E* to travel back to the position where it is stopped by the knurled stop-nut *R*. Any desired stopping point can be obtained by adjustment of the stop nut.

Band switches are controlled by cable *S*, which is directly actuated by pulley *T* mounted on the shaft of the rotary cage. The drive cable is wrapped around pulley *T* and fastened firmly at one point on the rim. One end of the cable runs down the side of the housing and is used to control band switches located below the tuning device. The other end of the cable goes up to guide pulley *U*, across to pulley *V*, around it and connects to spring *W* which holds the cable under tension. The cable is firmly attached at one point to the rim of pulley *V*. This pulley is mounted on the shaft of a standard band switch having eleven positions and 30-degree spacing between each position.

Since the threaded rods of the rotary cage are spaced 30 degrees apart, it is apparent that with each change in position of the cage a corresponding change is made in the setting of the band switch. Any reasonable number of band switches can be connected to drive cable *S* and the band switches may be located in any position in the transmitter, either below the tuning device or above it.

As shown in the photograph, the complete automatic tuning device is simply multiplication of the parts described in the foregoing paragraphs. Five adjustable knurled stop nuts are placed on each of the eleven threaded rods composing the rotary cage, and five sliders are mounted on the one guide bar. This permits tuning five variable condensers in one operation. The crystal selector switch and all necessary band switches are operated by drive cable *S*.

Construction details of the automatic tuning device are clearly shown in the drawing and photograph. The housing has an overall width of 19 inches, a height of 8¾ inches and a depth of 5 inches. The end plates of the rotary cage are cut

Operating Pleasure

Bliley Vari-X
VARIABLE CRYSTAL OSCILLATOR

FREQUENCY FLEXIBILITY
with **CRYSTAL STABILITY**

The Bliley Vari-X, with VF2 wide range variable crystal units, provides V.F.O. flexibility with full crystal stability. Circular D2, obtainable from your Bliley Distributor, gives complete information.

BLILEY Vari-X
VARIABLE CRYSTAL OSCILLATOR

IT'S A TRANSMOGRIFICATION



Our new light, unbreakable, transparent, fully weatherproof insulator. Dielectric constant 3.0-3.6. Special 10" x 1" size only \$1.50 net.

CARINI TELECTECHNIC LAB., Wethersfield, Conn.

1200 RADIO EXAMINATION QUESTIONS ANSWERED!

Just Published

SEVENTH (1940) EDITION

Nilson & Hornung's

RADIO OPERATING QUESTIONS AND ANSWERS

Covers all elements, 1 to 6, of the sample questions published by the F.C.C. in their "Study Guide for Commercial Radio Operators' Examinations." Includes Basic Laws, Theory and Practice, Radiotelephony, Broadcasting, Radiotelegraphy and Marine Radio. Ideal handbook for students and operators. Pocket size, flexible. Price \$2.50, postpaid. Money back if not satisfied. Send check or money order . . . not cash. Free circular on request.



NILSON RADIO SCHOOL
51 East 42nd St., New York, N. Y.

EMERGENCY NETS!

CONSULT with us about your radio requirements. We supply equipment to meet any conditions. Transmitters, receivers, transceivers, batteries, gas driven generators, etc. Demonstrations may be arranged.

We've been furnishing many of the Abbott DK-2 2½ meter transceivers to municipalities and organizations for emergency communication work with most satisfactory results. This complete "walkie-talkie" unit, with batteries, tubes, antenna, and handset costs under \$30.00.

(Incidentally, Hams, 112 Mc. is rapidly becoming a well populated and popular band. Get in the fun!)

• WANT A NEW RECEIVER?

I HAVE THEM ALL! Lowest prices — easiest monthly payment terms — best trade-in deal — and my personal guarantee that you'll be 100% satisfied. It will pay you to write to me for any Amateur Equipment!

73

Bill Harrison, W2AVA

NEW SX-28 SUPER SKYRIDER

The new 15-tube receiver that is the talk of the radio world. It has just about everything! Designed to government specifications, priced for amateurs. **\$159.50**

(Buy it on my easy terms)

UTAH POWER SUPPLY KITS

A sturdy, heavy duty supply for that 300 watt final or modulator. Delivers 1100 volts DC at up to 280 MA and 10 volts AC at 7 amps. (run filaments of 5 volt tubes in series).

All parts are standard and conservatively rated. Heavy metal chassis comes with all holes drilled; black wrinkle finish to match components. Uses two 866 rectifiers. Weight 48 pounds!

HERE IS WHAT YOU GET — ALL FOR ONLY

\$16.95

Husky plate transformer
Dual filament transformer
Swinging filter input choke
4 Mfd., 1500 volt working oil condenser
50M ohm bleeder
9" x 17" drilled chassis
Sockets, switches, pilot lights, fuse mount, small parts, instructions, etc.

TOTAL NET VALUE OVER \$27.00!

This is an exceptional bargain (even for a Harrison "Special"). The quantity is limited — so don't delay — **ORDER NOW!**

CRYSTAL MICROPHONES

Brand new, latest model Crystal Microphones. Excellent voice response. High output level. Attractive statuary brown finish. Fit any standard stand. Complete with 6 foot shielded cable.

\$3.79

Another Harrison "SPECIAL"

Mail and phone orders are promptly shipped

Combination hand/desk stand with matching finish. **SPECIAL 59¢**

THE HARRISON GUARANTEE IS YOUR ASSURANCE OF SATISFACTION!

12 West Broadway • New York • WOrth 2-6276

• HARRISON •
RADIO COMPANY

to a diameter of 4½ inches. Drive pulleys should have a diameter of from 1½ to 2 inches; guide pulleys a diameter of from ¾ to 1 inch. The guide bar over which the five sliders run should be made of smooth stock and bolted at each end to the housing.

To provide 330-degree rotation of the band switches threaded groove pulleys are necessary. In Fig. 1 pulleys of this type are shown as T and V. They should be 2 inches in diameter, approximately ½ inch in thickness and machined to have four running thread grooves sufficiently wide and deep to hold the flexible cable. Running thread pulleys are required to prevent the cable from riding over itself as the pulley goes through 330-degree rotation. As in the case of all pulleys, the running thread pulleys should be drilled for a ¼-inch shaft and arranged for set-screw attachment to the shaft. It is suggested that the running groove pulleys be turned out by the local machine shop. In all probability all the other pulleys can be obtained from the local hardware store.

Careful study of Fig. 1 and the photograph will confirm the statement that construction of the automatic tuning device is simple and straightforward. Suffice to say, construction can easily be accomplished by following the illustrations, which eliminate the necessity for a lengthy verbal description of each component tending to confuse the builder.

After the tuning unit has been built, assembled and cabled, the device can be installed in a convenient position on the front of the transmitter. It is a simple matter to hook up the various condensers and band switches, the method being clearly shown in Fig. 1. Metallic dial cable, approximately ¾ inch in diameter, is used for all cabling. It can be obtained from the local radio distributor.

It can be easily seen that this device meets the requirements mentioned at the start of this arti-

AMATEUR RADIO LICENSES

Day and Evening Classes in Code and Theory

HOME STUDY COURSES

Reasonable, Efficient and Thorough, Hundreds of Licensed Students Now on the Air

American Radio Institute, 1123 Broadway, New York, N. Y.

REMEMBER

Only Until September 1

To take advantage of the combination offers as advertised in the July and August issues.

cle. It can be applied to any form of transmitter, and the control cables will operate the various condensers and band switches no matter where they are placed or in what position they are mounted. This makes it possible to design a transmitter entirely from the standpoint of electrical efficiency. Aside from the device itself, no parts that would not be used in a manually-tuned transmitter are necessary. The simplicity and ease of adjustment of the device are self-evident.

Actually, operation can be compared to shifting gears in an automobile. The operating handle is the "clutch" and the selector knob the "gear-shift." The entire operation of changing bands and/or selecting new frequencies takes place while you count three . . . turn the operating handle, turn the selector knob to desired frequency and release the operating handle!

It is hardly necessary to mention the safety factor provided by automatic tuning. Once the bands are lined up and desired frequencies established, there is no necessity for further adjustment inside the rig. Bands can be changed without touching a single coil or condenser that may be loaded with lethal d.c. Best of all, everything is accomplished by a twist of the wrist.

This system of automatic tuning has been in use since October, 1938, and has proved itself to be entirely practical and satisfactory. Speed of frequency change and band switching have been repeatedly demonstrated in hundreds of "on the air" contacts. The general reaction of the gang is best expressed in the remarks of a W1 who, after recovering from his surprise, said, "That's really wonderful and almost unbelievable. BUT whatever you have there, I know it's too expensive for me!" He was mistaken, however. Any amateur who can afford a modern medium power transmitter can afford automatic tuning.

F.M. Limiter Performance

(Continued from page 21)

the signal generator's output was further increased, the limiter grid current also increased and the noise output decreased as shown in Fig. 4. It will be noted that for really good noise suppression a limiter current of about 1600 microamperes was necessary, in which case the reduction in noise was approximately 42 db. If the signal strength of the carrier was increased to obtain higher values of limiter current there was not a great deal of tendency to reduce noise after about 2000 microamperes limiter grid current had been reached. This effect is probably the result of a small amount of residual noise or hum in the audio system, since the signal-to-noise ratio should theoretically increase with increased carrier strength in a linear fashion.

Constants and Voltages

To determine the best circuit constants for optimum limiter performance, data were taken with various values of plate and screen voltages on the 6SJ7, and with several values of resistors in the grid circuit. From the standpoint of the ama-

MORE ACCURATE SIGNALS...by

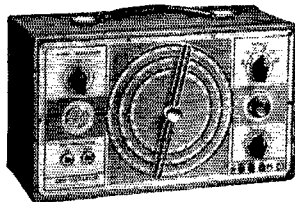

**New RCA Test Oscillator
No. 167**

New, easy-reading, accurate dial-scale...1.0 Full Volt Maximum R.F. Signal...100 to 30,000 Kc. fundamentals in six bands. Sixth-Band Harmonics for U.H.F. testing. 400-cycle, 8-volt audio. Only \$34.50 net.

**Electronic Sweep Test
Oscillator No. 150**

Internal electronic frequency modulator sweeps at 120 cycles. 1 to 40 Kcs. adjustable range at any output frequency. Accurately calibrated. R.F. frequency 90-32,000 Kcs. fundamentals. Only \$64.50 net.

For checking, testing and servicing radio circuits, rely on signal-source accuracy!

Signalyst

The modern signal generator for television and all receivers. Buffer stage between oscillator and output prevents reflected impedances in circuit tested from changing oscillator frequency. 100 Kc. to 120 Mc. in fundamentals. Metered output, etc. Write for details. \$107.50 net.

**Beat Frequency Audio
Oscillator No. 154**

Sine-wave audio, 30-15,000 cycles, for running fidelity curves, testing speakers, speech amplifiers, locating cabinet rattles. 5 RCA Tubes. Only \$49.95 net.



Test Equipment

RCA Mfg. Co., Inc., Camden, N. J. • A Service of the Radio Corporation of America

FULLFILL YOUR AMBITION IN RADIO COMMUNICATION



Newly-written, low-cost, home-study courses for training yourself for that radio job, or promotion. Fit yourself for examinations — 1st or 2nd class radio telephone operator's license and radio telegraph operator's permit — under new government requirements. You need up-to-date instruction to meet present day competition. Thousands of radiomen use Nilson and Hornung textbooks. Now, you can get detailed, up-to-date courses written and directed by Arthur R. Nilson. Use coupon below as your next step toward success!

FREE BOOKLET "What The Modern Radioman Must Know"

Contains 16-pages showing the wide scope of Nilson's home-study courses. Send for it now!

NILSON RADIO SCHOOL
51 East 42nd St., New York, N. Y.



Please send me without obligation, your booklet "What The Modern Radioman Must Know."

Name.....
Address.....
City.....State.....Q-9

PINCOR A SIZE FOR ANY JOB DYNAMOTORS

Leading radio engineers agree that Pincor Dynamotors take the grief out of "B" power supply problems. They are built properly to give thousands of hours of smooth, quiet, dependable operation under all conditions. Types and capacities to meet any requirements for aircraft, marine and broadcast service, police units, sound systems, auto radios, etc. 5 to 850 watts. Input, 6 to 110 volts; output, up to 1750 volts. Mail coupon for complete information.

ROTARY CONVERTERS

A complete line for converting 6, 12, 32, 110 or 220 volts D. C. to 110 or 220 volts A. C. 40 to 3000 watts.



PIONEER GEN-E-MOTOR CORP.
CHICAGO, ILLINOIS
Export Address: 25 Warren St., New York, N.Y.
Cable: Simontrice, New York

PIONEER GEN-E-MOTOR CORPORATION
Dept. R-61, 406 W. Superior St., Chicago, Illinois
Please send information on Pincor Dynamotors, Motor Generators and special power supply units.

Name.....
Address.....
City..... State.....
 Also send me Rotary Converter Catalog

LEARN RADIO • TELEVISION

60-page catalog on request. Oldest, largest and best equipped in New England. Fall term, Sept. 9. Write for new catalog.

MASS. RADIO SCHOOL

18 Boylston Street Boston, Massachusetts

Piezo-Electric Crystals Exclusively

- Quality crystals of all practical frequencies supplied SINCE 1925. Prices quoted upon receipt of your specifications.

Our Pledge: **QUALITY FIRST**

SCIENTIFIC RADIO SERVICE

"The Crystal Specialists Since 1925" University Park, Hyattsville, Md.

AUTOMATIC SENDERS

Type S — Sends 4 to 60 W.P.M. 10 rolls of double perforated tape made up of carefully selected and arranged matter for the most practical results. **\$20.00**

Type J — Sends 6 to 60 W.P.M. Practise tape and 5 rolls of blank tape. Make your own special tapes with built-in tape perforator. **\$12.50**

If your dealer can't supply you, write us

Gardiner-Levering Co. Haddon Heights
New Jersey, U. S. A.

RADIO COURSES

Start September

RADIO OPERATING • BROADCASTING • CODE
RADIO SERVICING • TELEVISION

- ELECTRONICS — 1 year day course; 2 years eve.
Day and Evening Classes — Booklet upon request

NEW YORK YMCA SCHOOLS
4 West 63rd Street, New York City

teur it is particularly desirable to use the values which will produce the best signal-to-noise ratio on weak signals. Superficial experiments on the various constants showed that varying most of these not only gave a change in noise suppression but also a change in audio voltage developed by the detector. Therefore it was necessary to make a test set-up in which the comparative signal-to-noise ratio could be determined.

An unmodulated carrier on 44 Mc. was fed into the antenna system of the frequency-modulation receiver. The antenna system also picked up noise from a universal motor. The plate and screen voltages and the resistance in the grid circuit of the 6BSJ7 were varied and the output noise which was developed in the power tube of the audio amplifier measured. Data could thus be readily obtained on the noise suppression. However, to obtain signal-to-noise ratio it was necessary to frequency modulate 50 kc. either side of the center frequency and to measure the audio voltage developed. The audio voltage thus produced in the detection circuit was divided by the voltage developed by the noise. It should be pointed out that this signal-to-noise ratio is only comparative, since it was much simpler to measure the voltage developed by noise in the output of the audio amplifier while the signal voltage with the noise absent was measured in the detection circuit. The audio volume control was adjusted so that the noise output was 22 db when the receiver was tuned off the carrier frequency. To get a comparatively weak signal, the carrier strength was adjusted so that the current in the limiter circuit was 0.5 ma. with $E_p = 25$ volts, $E_s = 75$ volts and $R = 10,000$ ohms. The data obtained are shown in Figs. 5, 6, 7, and 8. The plate voltage was used as an independent variable and the screen voltage and limiter resistance as parameters. It will be noted that, from the curves in Fig. 6, the best signal-to-noise ratio seemed to be obtained with a limiter resistance of about 5000 ohms, a plate voltage of about 20 volts and a screen voltage of about 50 volts. In checking these values by ear with a signal from W1XOJ and adjusting the pickup so that the signal was comparatively weak, it was found that these were substantially correct, though it was difficult to justify by ear the quite prominent peak shown in

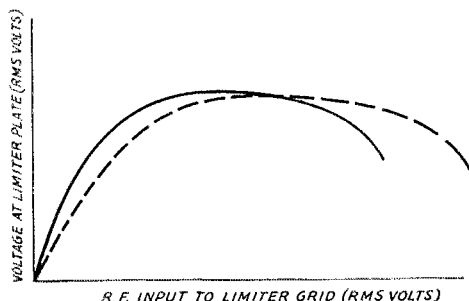

Fig. 9 — Typical limiter operating characteristics. The dashed curve shows the effect of the grid resistor in increasing the range over which proper limiting action is obtained.

Fig. 6. Adjusting the various values by ear when the signal strength from WIXOJ was about 1 ma. in the limiter circuit, it was found that a screen voltage of about 75 volts and a plate voltage of about 30 volts seemed to give better noise reduction, so that it is probable that the constants vary somewhat according to the signal strength.

It should be appreciated that the above data include the noise reduction in the limiter and also that due to the method of detection, which tends to balance out any impulses which may be picked up and passed through the i.f. amplifier at 3 Mc. Anyone who has tuned a frequency modulation receiver will have noticed that the best noise reduction is obtained when the receiver is correctly tuned, and that noise materially increases on either side of this tuning point.

This tuning for minimum noise will amount to the same thing as tuning for maximum limiter current of all of the i.f. transformers and the detection transformer are in perfect alignment. However, if the detection transformer is the slightest amount out of adjustment, maximum limiter current and minimum noise may not correspond. The latter condition is the correct tuning adjustment.

The operation of the limiter tube may be explained by referring to Fig. 9, which shows a plot of the r.f. voltage developed in the plate circuit of the limiter vs. the input signal r.f. voltage fed to the grid of the same tube. Limiting action is obtained by working the limiter tube with low plate and screen voltages. As the input signal is increased the output voltage rises until a certain value of input voltage is reached, whereupon the curve flattens off. The curve remains substantially flat for larger input signals until another point is reached where an increase in input results in an actual decrease in output. This decrease in output results because electrons ordinarily flowing to the plate are diverted to the grids. It is obvious that best limiting will be obtained when operation is over the flat portion of the curve; with strong carrier levels it is possible to push the operating point beyond the second bend of the curve, resulting in poorer limiter operation than with weaker signals. To counteract this effect a resistor is placed in the grid circuit of the limiter tube, causing the downward bend of the curve to occur at higher input levels without seriously changing the point at which saturation begins to occur. This is shown by the dotted curve. From the foregoing it is evident that the value of the resistor will be determined to a large extent by the average signal input level encountered. A value of 10,000 ohms has been found most satisfactory for the reception of broadcast signals. For weaker signals such as may be encountered in amateur work a smaller value gives better results, as previously shown.

The writer wishes to acknowledge the fine cooperation of the personnel of station WIXOJ. Many times after midnight the station remained on the air transmitting modulated and unmodulated signals for measurement purposes.

VOLTS? OHMS? MILLS? DECIBELS? AMPERES? Here's The Answer!

The New PRECISION Series 854 SUPER-SENSITIVE TESTER

Designed to meet the exacting requirements of Amateur, Laboratory, Industrial, Television and Radio.



- 6,000 VOLTS
- 60 MEGOHMS
- 12 AMPERES

20,000 ohms per volt DC
1,000 ohms per volt AC
★ SEVEN D.C. and SEVEN A.C. voltage ranges to 6,000 VOLTS. ★ SEVEN D.C. current ranges 0-60 MICRO-AMPERES. ★ THREE resistance ranges to 60 MEGOHMS (self-contained batteries). ★ SIX decibel ranges from -12 to +70 DB. ★ SEVEN output ranges to 6,000 VOLTS. ★ 4 1/2" wide-faced, 50 microampere meter. ★ 1% wire-wound bobbins and matched metalized multipliers. 2% D.C. and 3% A.C. overall accuracy.

SERIES 854P (illustrated) with batteries and high voltage test leads. Net Price . . . \$39.95
More than 40 models in the PRECISION 1941 LINE
Mutual Conductance Type Tube Testers and Set Testers, 16 Multi-Range Testers, Signal Generators, etc. . . . See them at your local distributor . . .

Ask for the PRECISION TEST EQUIPMENT 1941 CATALOG

PRECISION TEST EQUIPMENT
Standard of Accuracy SEE THEM AT YOUR JOBBER

PRECISION APPARATUS COMPANY
647 Kent Avenue Brooklyn, New York
Export Div.: 458 Broadway, New York, U. S. A. — Cables: Morhanex



E. H. Rietske
Pres. CREI

It's YOUR Job Today to prepare for a better job tomorrow in Practical Radio and Television Engineering

● Don't say you never had the chance to step into a better-paying job — for that opportunity is here today! Radio wants — and needs technically trained men for important jobs that new methods and equipment have created. Your own radio experience is a most valuable asset if used as the basis for modern technical training in Practical Radio and Television Engineering.

Just Off the Press!
**Write for
FREE Booklet**

To help us send complete details, please state briefly your radio experience, education and present position — and if interested in home study or residence course.



Make More Money

CREI home-study and residence courses can increase your ability to qualify for a better job. The only difference between a \$1800 a year man and a \$4000 man is the added ability gained through training. If you want more money and a real future in radio — today's your chance to send for our important story.

**One Year Residence Course
Begins September 23**

Still time to enroll. Wire or write for special catalog and details. Day and evening classes.

Capitol Radio Engineering Institute
Dept. Q-9, 3224 16th St. N.W., Washington, D.C.

Summer Specials

QUALITY VALUES
GUARANTEED TO SAVE YOU MONEY!

BEEDE MILLIAMMETERS

NEW! PERFECT! Standard moving coil construction. 3" diameter, square bakelite case. Available in the following ranges:
 0-5 MA. 0-50 MA. 0-250 MA.
 0-10 MA. 0-100 MA. 0-500 MA.
 0-25 MA. 0-200 MA. 0-300 MA.

YOUR CHOICE, any type.....\$2.39

2 1/2 V. FILAMENT TRANSFORMERS

Rated at 10 amps. 10,000 volt insulation. Provided with bracket mounting. Fully guaranteed. Quantity limited.
YOUR COST.....80¢

DECKER BABY TANK COILS

FOR 10-20-40-80-160 METERS
 5 prong base. Available with center link or end link.

YOUR COST, any type.....60¢
 If ordering by mail, kindly specify 2nd and 3rd choices inasmuch as the quantity on hand is limited.

Write for your copy of

SUN'S SPECIAL SUMMER BULLETIN

Contains bargains and values galore! Includes a large selection of new and some used receivers accepted as trade-ins. Here's your opportunity to pick up a good receiver at a tremendous saving. Also scores of parts and apparatus that you can use—priced exactly right!

★ ★ ★ NEW! ★ ★ ★

ASTATIC R-3 CRYSTAL MICROPHONE

Never before has such a fine quality microphone been offered to the radio amateur at such a remarkably low price! Provides smooth frequency response from 30 to 5000 c.p.s. Complete with 7 ft. cable.
YOUR COST.....\$5.85

ECHOPHONE EC-1 RECEIVER

A new 6 tube communications receiver for 110 volts A.C. or D.C. operation. Covers 10-550 meters. Note these features! A.V.C.—B.F.O.—Standby Switch—Electrical Bandspread.
PRICE, complete with tubes and dynamic speaker.....\$19.95

JENSEN EXTENDED RANGE — HIGH FIDELITY REPRODUCER

The last word in "woofer-tweeter" combinations. 15" dual concentric type P.M. speaker with built-in filter network. Frequency response 35 to 14,000 c.p.s. Ideal for quality P.M. and Television receivers, monitoring and studio work.
YOUR COST.....\$27.34

FREE! NEW P. A. CATALOG

A lavishly illustrated 24-page booklet. Lists hundreds of interesting values in the public address field. Send for your copy today.

New York's Oldest "Ham" House

W2JEH — W2DXC — W2LFV — W2CLH



SUN RADIO CO.
 212 Fulton Street, Dept. LT New York
 Cable Address: SUNRADIO NEW YORK

Scores WAS Party

(Continued from page 41)

W2LEY	1650-22-75	W9ZYS	400-16-25
W5EQC	1638-26-63	W7DFU	387-9-43
W9GDB	1612-31-52	W4EHT*	385-11-35
W8JAH*	1600-25-64	W1KZR	379-13-29
W8JFC**	1600-20-80	W6ISC*	375-15-25 ¹⁷
W8GRT	1558-19-82	W1MCQ	370-10-37
W8MST**	1540-22-70	W7AXS	360-9-40
W8ROA	1533-21-73	W9FVU**	330-11-30
W8NQS	1530-30-51 ¹⁰	W6CHV	324-6-54
W7UQ	1500-25-60 ¹¹	W8QBR	312-13-24
W9ZSS*	1475-25-59	W9BAZ*	308-14-22
W6PYH	1464-12-122	W1AAZ	300-12-25
W1LYA	1440-20-72	W6ZT*	297-11-27
W1CIU**	1440-20-72	W8SVO	290-10-20 ¹⁸
W8SLW*	1387-19-73	W1CEA	288-9-32
W9HUV*	1375-25-55	W1EWN	286-11-26
W9RBR**	1364-22-62	W6RH*	286-13-22
W4DID	1363-20-47	W8UIW	286-13-22
W2LTC	1300-20-65	W9QFH	255-15-17
W8QEZ	1274-14-91	W8QLW	234-8-28
W3ADE**	1178-19-62	W7HLH	221-13-17
W4BYN	1166-22-53 ¹²	W1KQT	216-9-24
W2MLM	1159-19-61	W8SAF	216-12-18
W7HBC	1155-15-77	W6CIS*	209-11-19
W2HAB*	1140-19-60	W8PK*	209-11-19
W9CNI**	1140-20-70	W2HAP	204-12-17
W1MHL	1120-16-75	W5EKY	200-8-25
W7GNJ	1120-14-80	W6FDJ	180-9-20
W8AHV	1035-26-44	W2LMQ	170-10-17
W3EQK	1056-24-44	W7RLO	170-10-17
W2DEN*	1054-17-62	W9ENX	170-5-34
W8FDA*	1050-21-50	W1LLP	168-5-21
W9FCY	1045-19-55	W8RJJ	160-10-16
W2KYV*	1008-18-56	W2LRZ	154-9-16
W3LID*	1008-18-56	W9DY*	152-8-19
W8CCY*	1008-18-56 ¹³	W7HFT	144-8-18
W9ZEA	1000-20-50	W4FWO	144-9-16
W9RZY*	890-20-49	W9EDY*	140-10-14
W3ACC	876-16-61	W9SXP	140-10-14
W2HUG*	969-19-51	W8EUF	128-8-16
W3HTJ*	954-18-53	W2KZB**	120-6-20
W8FUR*	940-20-47	W6ZM	110-5-22
W5ISC	924-21-44 ¹⁴	W9CVG*	110-10-11
W7FXO	903-21-43	W1GKJ	105-7-15
W8PBX**	882-18-49 ¹⁵	W6RBQ**	100-5-20
W5EEY*	851-23-37	W2DOC**	98-7-14
W9DMY*	840-21-40	W5CAQ	90-9-10
W1KIK*	800-20-40	W8RPP	84-4-21
W8QQB*	784-16-49	W7GVV	84-4-21
W8CON*	785-17-45	W2MRO	72-6-12
W1HJI	720-12-60	W9WYX	72-4-18
W9BRO**	720-20-36	W9EUF**	66-6-11
W2KON	714-14-51	W8FJ*	56-7-8
W8PU*	690-15-46	W8RVM	54-6-9
W2HXI*	684-19-36	W8FR*	42-6-7
W9QLD**	684-19-36	W2MIO	40-4-10
W1FVH*	675-15-45	W8NGK	40-2-20
W4FCW	666-18-37	W1ON	35-5-7
W9EIQ**	665-19-35	W9VVF	35-5-7
W9EXB	646-19-34	W9ZHR	30-3-10
W8QB*	638-22-29	W9MZM	27-3-9
W1CJH	624-13-48	W2DLK	20-4-5
W2HSP	600-15-40	W9DLK	20-4-5
W1HGX*	592-16-37	W1LTP	15-3-5
W8SFG	588-14-42	W9AEJ*	15-3-5
W3GWQ	578-17-34	W1BGJ*	12-3-4
W6PDV	572-13-44	W5EUY	12-3-4
W2ION*	560-14-40	W9YZV	9-1-9
W8LCY*	540-15-36	W8MTO	9-2-4
W9MRQ*	528-16-33	W9QDC	9-1-8
W9OPA	527-17-31	W2IDS	7-1-7
W8BTQ	481-13-37 ¹⁶	W9KVV*	5-1-5
W6NLI**	480-12-40	W6RAK	4-2-2
W2MOY*	473-11-43	W5BZG	2-1-2
W3AJS*	465-15-31	W6DHS	2-1-2
W1JEA*	462-14-33	W1KCT	1-1-1
W9CGM	450-18-25	W9AIR*	1-1-1
W8QDP*	448-14-32	W9OGS	1-1-1
W9VXS	440-10-44	W1TS*	7004-34-206 ¹⁹
W4BIA	420-20-21	W1AW**	3900-30-130 ¹⁹⁻²⁰
W2HBO*	416-13-32	W1MBC*	1452-22-66 ¹⁹
W8SGL*	400-16-25	W1UE**	1005-15-67 ¹⁹
		W1JMY*	45-5-9 ¹⁹

SWITCH TO SAFETY!



Where to buy it

A directory of suppliers who carry in stock the products of these dependable manufacturers.



ALBANY, N. Y. Uncle Dave's Radio Shack 356 Broadway
 ATLANTA, GEORGIA 265 Peachtree Street
 Radio Wire Television Inc.
 BOSTON, MASS. Radio Shack 167 Washington Street
 BOSTON, MASS. 110 Federal Street
 Radio Wire Television Inc.
 BRIDGEPORT, CONN. 177 Cannon Street
 Hatry & Youngs, Inc.
 BRONX, N. Y. 542 East Fordham Rd.
 Radio Wire Television Inc.
 BUTLER, MISSOURI 211-215 N. Main Street
 Henry Radio Shop
 CHICAGO, ILL. 833 W. Jackson Blvd.
 Allied Radio Corp.
 CHICAGO, ILL. 901-911 W. Jackson Blvd.
 Radio Wire Television Inc.
 CINCINNATI, OHIO 1103 Vine Street
 United Radio, Inc.
 DETROIT, MICH. 325 E. Jefferson Ave.
 Radio Specialties Co.
 DETROIT, MICHIGAN 11800 Woodward Ave.
 Radio Specialties Co.
 HARTFORD, CONNECTICUT 227 Asylum Street
 Radio Inspection Service Company
 HOUSTON, TEXAS 1021 Caroline Street
 R. C. & L. F. Hall
 INDIANAPOLIS, INDIANA 34 West Ohio Street
 Van Sickle Radio Supply Co.
 JAMAICA, L. I. 90-08 166th Street
 Radio Wire Television Inc.
 KANSAS CITY, MO. 1012 McGee Street
 Burstein-Applebee Company
 NEW HAVEN, CONN. 1172 Chapel Street
 Hatry & Youngs, Inc.
 NEW YORK, N. Y. 12 West Broadway
 Harrison Radio Co.
 NEW YORK, N. Y. 100 Sixth Ave.
 Radio Wire Television Inc.
 NEWARK, N. J. 24 Central Ave.
 Radio Wire Television Inc.
 READING, PENN. 404 Walnut Street
 George D. Barbey Company
 SCRANTON, PENN. 519-21 Mulberry Street
 Scranton Radio & Television Supply Co.
 WASHINGTON, D. C. 938 F Street, N. W.
 Sun Radio & Service Supply Co.

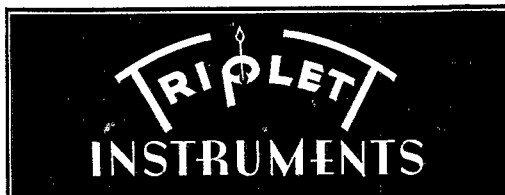

ALBANY, N. Y. Uncle Dave's Radio Shack 356 Broadway
 ATLANTA, GEORGIA 265 Peachtree Street
 Radio Wire Television Inc.
 BOSTON, MASS. Radio Shack 167 Washington Street
 BOSTON, MASS. 110 Federal Street
 Radio Wire Television Inc.
 BRIDGEPORT, CONN. 177 Cannon Street
 Hatry & Youngs, Inc.
 BRONX, N. Y. 542 East Fordham Rd.
 Radio Wire Television Inc.
 BUTLER, MISSOURI 211-215 N. Main Street
 Henry Radio Shop
 CHICAGO, ILLINOIS 833 W. Jackson Blvd.
 Allied Radio Corp.
 CHICAGO, ILL. 901-911 W. Jackson Blvd.
 Radio Wire Television Inc.
 CINCINNATI, OHIO 1103 Vine Street
 United Radio, Inc.
 HARTFORD, CONN. 203 Ann Street
 Hatry & Youngs, Inc.
 JAMAICA, L. I. 90-08 166th Street
 Radio Wire Television Inc.
 LITTLE ROCK, ARKANSAS 409 W. 3rd St.
 Beem Radio Company
 MINNEAPOLIS, MINNESOTA 1124-26 Harmon Place
 Lew Bonn Company
 NEW HAVEN, CONN. 1172 Chapel Street
 Hatry & Youngs, Inc.
 NEW YORK, N. Y. 100 Sixth Avenue
 Radio Wire Television Inc.
 NEWARK, N. J. 24 Central Ave.
 Radio Wire Television Inc.
 READING, PENN. 404 Walnut Street
 George D. Barbey Company
 SCRANTON, PENN. 519-21 Mulberry Street
 Scranton Radio & Television Supply Co.
 WASHINGTON, D. C. 938 F Street, N. W.
 Sun Radio & Service Supply Co.

Listings on this page do not necessarily imply endorsement by QST of the dealers or of other equipment sold by them.

COMPARE *Crystal Performance*

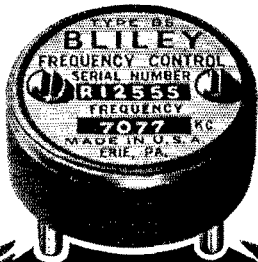

Place a B5 40-meter Crystal Unit in your transmitter and observe its performance. See how it snaps into oscillation instantly and maintains constant output. Set your monitor to zero beat and note the low frequency drift as the crystal warms up. Measure the frequency and check the accurate calibration stamped on the nameplate.

Dependable performance is built into B5 40-meter Crystal Units. You can get them from your Bliley Distributor for only \$4.80. Bliley Electric Co., Erie, Pa.

BLILEY B5 40-METER UNIT

RADIO TECHNOLOGY



RCA Institutes offer an intensive course of high standard embracing all phases of Radio and Television. Practical training with modern equipment at New York and Chicago Schools. Also specialized courses in Aviation Communicators, Radio Servicing and Commercial Operating. Illustrated Catalog on request

RCA INSTITUTES, INC. Dept. ST-40

A Radio Corporation of America Service

75 Varick St., New York 1154 Merchandise Mart, Chicago

SICKLES COILS

ALL TYPES OF RF AND IF WINDINGS

Manufactured by

F. W. SICKLES COMPANY

300 Main Street

Springfield, Mass.



DYNAMOTORS

Famous for Performance! From the smallest in size to the largest in output. Ideal Power Supply for Mobile Communications equipment.

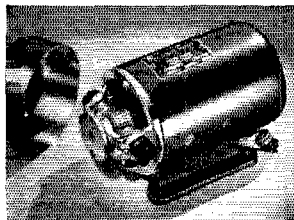

Write Today for Data

EICOR INC.

513 S. Laflin Street
Chicago, Illinois

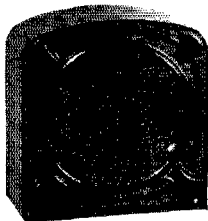

OXFORD

Auxiliary "MIKE"

Oxford model 3ZM-CM auxiliary "MIKE" is a Ham necessity. Housed in an attractive bakelite case only 4" x 1 1/4" x 2" this handy unit is ideal for quick and reliable replacement in case of sudden microphone failure. Has excellent voice frequency response and is highly satisfactory for permanent use on less expensive rigs.

List Price \$4.50

A similar unit designed for use as speaker only is available in identical case under model No. 3ZM-CA.

List Price \$3.50

OXFORD-TARTAN
RADIO CORPORATION

915 W. VAN BUREN ST. • CHICAGO, U. S. A.



Write Dept. Q for descriptive literature and complete speaker catalog

HAM-ADS

(1) Advertising shall pertain to radio and shall be of nature of interest to radio amateurs or experimenters in their pursuit of the art.

(2) No display of any character will be accepted, nor can any special typographical arrangement, such as all or part capital letters be used which would tend to make one advertisement stand out from the others.

(3) The Ham-Ad rate is 15¢ per word, except as noted in paragraph (6) below.

(4) Remittance in full must accompany copy. No cash or contract discount or agency commission will be allowed.

(5) Closing date for Ham-Ads is the 25th of the second month preceding publication date.

(6) A special rate of 7¢ per word will apply to advertising which, in our judgment, is obviously non-commercial in nature and is placed and signed by a member of the American Radio Relay League. Thus, advertising of bona fide surplus equipment owned, used and for sale by an individual or apparatus offered for exchange or advertising inquiring for special equipment, if by a member of the American Radio Relay League takes the 7¢ rate. An attempt to deal in apparatus in quantity for profit, even if by an individual, is commercial and all advertising by him takes the 15¢ rate. Provisions of paragraphs (1), (2), (4) and (5) apply to all advertising in this column regardless of which rate may apply.

Having made no investigation of the advertisers in the classified columns, the publishers of QST are unable to vouch for their integrity or for the grade or character of the products advertised

QUARTZ — direct importers from Brazil of best quality pure quartz suitable for making piezo-electric crystals.

Diamond Drill Carbon Co., 719 World Bldg., New York City.

QSL's — samples. Brownie, W3CJL, 523 No. Tenth St., Allentown, Pa.

CRYSTALS, mounted, 80-160, \$1.25, V-cut 40, \$2.25. R9 Crystals, 338 Murray Ave., Arnold, Pa.

USED receivers. Bargains. Cash only. No trades. Price list 3¢. W3DQ, Wilmington, Del.

CALLBOOKS — Summer edition now on sale containing complete up-to-date list of radio hams throughout entire world. Also world prefix map, and new time conversion chart. Single copies \$1.25. Canada and foreign \$1.35. Radio Amateur Call Book, 610 S. Dearborn, Chicago.

CRYSTALS: famous P.R., mounted in latest Aismag 35 holders — 40, 80 meter PR-X, 160 meter PR-Z, \$3; 40, 80 meter PR-Z (low drift), \$3.50; 20-meter PR-20, \$4.50; unconditionally guaranteed. Immediate shipment. Wholesale Radio Labs., Council Bluffs, Iowa, W9GFQ.

QSL'S, W8JOT, Box 101, Rochester, N. Y.

TELEPLEXES, Instructographs bought, sold. Ryan's, Hanibal, Mo.

MACAUTO code machines: low monthly rental 50,000 words practice tapes. Write N. C. Ayers, 711 Boylston St., Boston, Mass. Granite 7189-W.

CRYSTALS — 160-80 m. crystal, \$1. 160-80 m. crystal mounted in ceramic holder, \$1.75. Koradio, Mendota, Ill.

QSL's, all colors, cartoons, snappy service. Write for free samples today. W1BEF, 78 Warrenton, Springfield, Mass.

GENERAL Electric dynamotors 24/750 volts 200 mils, \$12.50. 500 watt 500 cycle alternators with exciters, \$8. 500 watt 6-16 volt Aircraft, \$8. Unused ex-navy material. Henry Kienzie, 215 Hart Blvd., Staten Island, N. Y.

CRYSTALS — police, marine, aircraft, amateur. C-W Mfg. Co., 1170 Esperanza, Los Angeles.

QSL'S, SWL's, 100-3 color — 75¢. Lapco, 344 W. 39th, Indianapolis, Ind.

WILL trade cameras, xylophone, drums, rifle for transmitter parts or receiver. W8UMZ, Brookville, Pa.

QST'S: Wanted — all previous December 1920. State condition, price. W2BNX.

QSL'S. Maps. Cartoons. Free samples. Theodore Porcher, 7708 Navajo, Philadelphia, Pa.

BARGAINS — selling out — write for list. W6OFQ, San Mateo, Calif.

FORCED to sell: brand new Stancor 110 C.M. transmitter. Used one month. Sacrifice. W9DSK, Camby, Ind.

QSL'S? — SWL's? America's finest. Immediate service. Free samples? W8DED, Holland, Mich.

WANTED: QST's — Vol. 1, No. 1; Jan., Feb., March, Aug., 1921; Jan., Feb., 1922. Wm. Connor, Belleville, Ont.

QSL'S. Finest. Free samples. Maleco, 1805 St. Johns Place, Brooklyn, N. Y.

CRYSTALS in plug-in heat dissipating holders. Guaranteed good oscillators. 160M — 80M, AT, \$1.25; 40X, \$1.65. 80M vari-frequency (5 kilocycle variance) complete, \$2.95. State frequency desired. C.O.D.'s accepted. Marine crystals 2738, 2670, etc., and 3105 aircraft mounted, lowdrift, .01% tolerance, \$6 each. Pacific Crystals, 1042 S. Hicks, Los Angeles.

ATTRACTIVE patriotic wall or call emblem, trimmed national colors, \$1.15. W9FDE.

QSL'S — SWL's. Colorful. Economical. W9KXL, 819 Wyandotte, Kansas City, Mo.

MODULATION monitors only \$12. Inquire Modomon, 2905 Bever Ave., Cedar Rapids, Iowa.

TRADE: radio gear for good camera and accessories. W2DQW.

WANTED: complete commercial built phone transmitter 160-10 meters, late model, Collins preferred. Cash. Arnold Badt, Benton Harbor, Mich.

EVERYTHING you want in a beam — continuous rotation, link coupled, hollow shaft, all-steel, hi-torque rotor, accurate self-synchronous indicator, non-corroding aluminum elements. Rotary Array Service, W8ML.

SELL — complete 250 watt fone transmitter. W9MLB, Gothenburg, Nebr.

QSL'S. Latest designs. W1CJD, Gildersleeve, Conn.

HOUR meters, comprising 110 v. sixty cycle synchronous motor, sealed gear reduction, Veeder counter. Register 9999.9 hours. Used briefly in Wired Radio field test. Determine operating costs of transmitter, refrigerator, oilburner, Photofloods, etc. Measure tube life. Motor alone (one RPM) invaluable. Beautiful ten dollar instrument for \$2.75 postpaid, while supply lasts. Allan Schumacker, Box 25, Ampere, N. J.

TRANSMITTING headquarters: 70 watt transmitters \$35; 5-10-20 Utah rigs \$35; Guthman transmitters \$22.50. All kits wired at lowest prices. Write Leo, W9GFQ, today.

RECEIVER bargains: New Howard 460's with crystal \$59.95; SX-23 only \$79.50; new 6 tube wonder \$19.95. Reconditioned Ultra-Skyrider \$39; Siky Champion \$29.50; HRO, Jr. \$59; PR15's \$59; ACR-175 \$49; Howard 438 \$29.50; S-15 \$34.50; SX-25 \$79.50; NC100 \$59; and other models guaranteed. Low terms, free trial. For best deal always write Leo, W9GFQ, Wholesale Radio Labs., Council Bluffs, Iowa.

SELLING out 300 watt transmitter — 20 meter Q antenna to V-2 microphone. Howard 450A receiver, crystal, speaker. Write W5HAY, Box 112, Weslaco, Texas.

\$100 f.o.b. takes complete station — photo, list. W8OGG, 940 Northampton, Buffalo, N. Y.

CRYSTALS, commercial or amateur: police, aircraft, marine and all types of low drift units for commercial services at attractive prices. Send for catalog. For the amateur; those dependable, fully guaranteed T9 crystals — the choice of thousands of hams. You'll like them too. 40, 80 and 160 meter bands, \$1.60 postpaid. Close frequency choice. T9 ceramic holder, \$1. C.O.D.'s accepted. Sold by: Our dealers previously listed and Bidson's, Temple, Texas.

FOR sale: complete station. 300 watt fone; 600 watt CW. HQ-120X receiver. 4-2000 v. 300 mil transformers; 10-5600 v. 1 Mfd. condensers (oil). Best offer. Write W9UXD.

WRITE Bob, W9ARA, for best deal on all amateur receivers, transmitters, kits, parts. You get best terms (financed by myself), largest trade-in, fairest treatment, lowest prices. Write. Bob Henry, W9ARA, Butler, Mo.

RECONDITIONED guaranteed receivers at lowest prices. All makes and models cheap. Ten day free trial. Terms. Write for free list. W9ARA.

FOR sale: \$20; Supreme model 590 multimeter 57 ranges; 25,000 ohms per volt sensitivity. Phone Euclid 8968. W9ANS.

400 w. CW station complete. Commercial type rack-panel transmitter, Silver 5-D communications receiver, frequency meter, recorder amplifier, Teleplex, field-strength meter, other accessories — no junk. Cost over \$400, sacrifice \$200. Photo on request. Consider terms to responsible local ham, or trade for portable-mobile equipment; good camera, enlarger; or what have you? W8LJT.

SELL: Late model SW-3, 20 m. coils, tubes, pack, \$15; QST — 1926 — date, \$25. W5ECW.

HQ-120X slightly used \$108, other parts cheap. W2LYP, Iaelin, N. J.

COMMERCIAL looking 400 watt phone rack job separate speech peak compression, like new, \$325. W2DCO, De Pasquale, 135 Liberty St., New York, N. Y.

HEAR everything broadcast to 10 meters, for \$19.95. New Bobophone EC-1 full bandspeed receiver. Appeals to whole family's listening desires. Makes dandy portable because of small size, metal cabinet, self-contained speaker, phone-speaker switch, doublet antenna provision, beat oscillator, stand-by switch. Terms to suit. Write or call today. Scell's Radio, Hartford, Conn.

WANTED: Old spark and other electrical equipment such as synchronous and mercury arc rectifiers, quenched spark gaps, mica transmitting condensers, transformers, big bottles, etc.; also good receiver, RME DB-20 preselector. Please state price desired. W5KD, 215 Northwest 19th St., Oklahoma City.

New Exams

NEW LICENSE MANUAL

The new examinations are based on the multiple-choice type of questions. This of course requires an entirely different approach on the part of the applicant studying to take the examination for license. The NEW "License Manual" has been written to make it as easy as possible for the individual to acquire the necessary knowledge to pass the examination with flying colors. Whether you are going up for your Class B or your Class A ticket, "The License Manual" will provide the most direct path to getting that ticket. If you are one of the thousands who always wants a "License Manual" around the shack for ready reference for amateur regulations, it will please you to know that the regulations are very thoroughly indexed.

Price 25c postpaid (no stamps, please)

AMERICAN RADIO RELAY LEAGUE
WEST HARTFORD, CONNECTICUT

U. S. NAVY WANTS 5400 RESERVE OPERATORS

The Communications Reserve of the United States Navy is enlisting 5400 expert radio operators!

You can qualify for your Amateur or commercial license and a good rating by taking CANDLER TRAINING in your own home as thousands of radio operators have done in the last twenty-five years. You will get the same training McElroy and McDonald, the WORLD'S CHAMPIONS, received.

The New BOOK OF FACTS gives you the story of the champions and inside tips that will help you. It is FREE. No obligation.



CANDLER SYSTEM CO.

Dept. Q-9
ASHEVILLE, NORTH CAROLINA

HIGH GRADE WIRELESS KEY

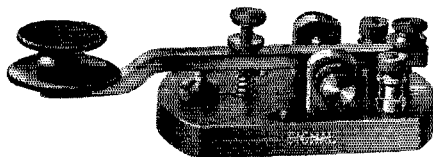

This standard wireless key is designed to carry heavy currents. All brass construction with lacquer finish. Furnished with 3/16, 1/4 or 3/8-inch coin silver contacts. Navy type key knob.

Type	Contacts	Code Word	Net Wgt.	Sh'g Wgt.	List Price
R-62	3/16"	SEMCLU	3/4 lb.	2 lbs.	\$3.50
R-63	1/4"	SEMVCV	3/4 lb.	2 lbs.	3.60
R-64	3/8"	SEMVCW	3/4 lb.	2 lbs.	3.85

See your favorite radio parts jobber
or write direct to

SIGNAL ELECTRIC MFG. CO., Menominee, Mich.

Established
1892



Your Nearby Dealer Is Your Best Friend

Your nearby dealer is entitled to your patronage. He is equipped with a knowledge and understanding of amateur radio. He is your logical source of advice and counsel on what equipment you should buy. His stock is complete. He can supply your needs without delay. His prices are fair and consistent with the high quality of the goods he carries. He is responsible to you and interested in you.

One of these dealers is probably in your city — Patronize him!

ATLANTA, GEORGIA

Radio Wire Television Inc.
265 Peachtree Street
"The World's Largest Radio Supply House"

BALTIMORE, MARYLAND

Radio Electric Service Co.
3 N. Howard St.
Everything for the Amateur

BOSTON, MASS.

Radio Wire Television Inc.
110 Federal Street
"The World's Largest Radio Supply House"

BRONX, NEW YORK

Radio Wire Television Inc.
542 East Fordham Road
"The World's Largest Radio Supply House"

BUFFALO, NEW YORK

Radio Equipment Corp.
326 Elm Street
W8PMC and W8NEL — Ham, service and sound equipment

BUFFALO, NEW YORK

Dymac Radio
1531 Main Street — Cor. Ferry
Open Evenings GA. 0252

HARTFORD, CONNECTICUT

Radio Inspection Service Company
227 Asylum Street
What do you want? We have it. Radio exclusively

HARTFORD, CONNECTICUT

Hatry & Young, Inc.
203 Ann Street
Stores also in Bridgeport and New Haven

HOUSTON, TEXAS

R. C. & L. F. Hall
1021 Caroline Street (C 0721)
"Specialists in Amateur Supplies"

JAMAICA, L. I., NEW YORK

Radio Wire Television Inc.
90-08 166th Street (Merrick Road)
"The World's Largest Radio Supply House"

NEWARK, N. J.

Radio Wire Television Inc.
24 Central Avenue
"The World's Largest Radio Supply House"

NEW YORK, N. Y.

Radio Wire Television Inc.
100 Sixth Avenue
"The World's Largest Radio Supply House"

NEW YORK, N. Y.

Harrison Radio Company
12 West Broadway
Harrison Has It! Phone WOrth 2-6276 for information or rush service

PHILADELPHIA, PENNSYLVANIA

Eugene G. Wile
10 S. Tenth Street
Complete Stock of Quality Merchandise

PROVIDENCE, RHODE ISLAND

W. H. Edwards Company
85 Broadway
National, Hammarlund, Hallicrafter, Thordarson, Taylor, RCA

RICHMOND, VIRGINIA

The Arnold Company
Broad at Harrison St.
W3EQQ — "The Virginia Ham Headquarters" — W3FBL

SCRANTON, PENNSYLVANIA

Scranton Radio & Television Supply Co.
519-521 Mulberry Street
Complete Stock of Quality Amateur Supplies

YOU CAN BE SURE
WHEN YOU BUY FROM

QST

ADVERTISERS

“Advertising for *QST* is accepted only from firms who, in the publisher’s opinion, are of established integrity and whose products secure the approval of the technical staff of the American Radio Relay League.”

Quoted from QST’s advertising rate card.

Every conceivable need of a radio amateur can be supplied by the advertisers in QST. And you will know the product has the approval of the League’s technical staff

Index to Advertisers

Abbott Instrument, Inc.	70
Aerovox Corp.	81
American Radio Institute	84
Astatic Microphone Laboratory, Inc.	54
Barker & Williamson	82
Bliley Electric Company	83, 90
Candler System Company	92
Capitol Radio Engineering Institute	87
Carini Telectechnic Lab.	83
Centralab	55
Collins Radio Company	Cov. 11
Dodge’s Institute	81
Eicor, Inc.	90
Eitel-McCullough, Inc.	51
Gardiner-Levering Company	86
General Electric Company	5
Hallcrafters, Inc., The	1
Hammarlund Mfg. Company, Inc.	57
Harrison Radio Company	84
Harvey Radio Company	76
Henry Radio Shop	2
Howard Radio Company	71
Hygrade Sylvania Corp.	66
Instructograph Company	74
Jensen Radio Mfg. Company	59
Johnson Company, E. F.	61
Kenyon Transformer Company, Inc.	56
Mallory & Company, Inc., P. R.	50
Massachusetts Radio School	86
Midland Radio & Television Schools, Inc.	77
Miller, Wayne	70
National Company, Inc.	Cov. III, 49
New York YMCA Schools	86
Newark Electric Company	75
Nilson Radio School	83, 85
Ohmite Mfg. Company	52
Oxford-Tartak Radio Corp.	90
Pioneer Gen-E-Motor Corp.	86
Port Arthur College	74
Precision Apparatus Corp.	87
RCA Institutes, Inc.	90
RCA Mfg. Company, Inc.	Cov. IV, 53, 85
Radio City Products	64
Radio Mfg. Engineers, Inc.	95
Radio Shack, The	65
Scientific Radio Service	86
Shuler Supply Company	88
Sickles Company, F. W.	90
Signal Electric Mfg. Company	92
Solar Mfg. Corp.	58
Sprague Products Company	60
Sun Radio Company	88
Taylor Tubes, Inc.	63
Teleplex Company	81
Terminal Radio Corp.	80
Thordarson Electric Mfg. Company	67
Triplett Electrical Instrument Company, Inc.	62
United Transformer Corp.	96
Ward Leonard Electric Company	82
Wholesale Radio Laboratories	84
Yaxley	50



THE NOW FAMOUS RME-99

NO MATTER WHERE YOU FIND IT

**RADIO MFG. ENGINEERS, INC., 111 HARRISON ST.
PEORIA, ILLINOIS**



For Special Components



Extensive research and development has placed UTC in an unequalled position for 'supplying transformers to customers' specifications. In addition to the various commercial users of UTC products such as G.E., RCA, Western Electric and Westinghouse, all government departments have UTC on the approved list.

May we assist you in your application?

UNITED TRANSFORMER CORP.

Write: COMMUNICATIONS DIV. ★ 150 VARICK ST. ★ NEW YORK, N. Y.
EXPORT DIVISION: 100 VARICK STREET NEW YORK, N. Y. CABLES: "ARLAB"

QST for September, 1940 EASTERN Edition

PRINTED IN U.S.A.
RUMFORD PRESS
CONCORD, N.H.



Ex KA1QL tells about his HRO

"About four years ago . . . the unit was shipped from Malden to Manila in the Philippines, a distance of approximately 10,000 miles and used in both commercial point-to-point service and by myself in amateur service. The prevailing conditions of extreme humidity and heat along with poor line regulation had no effect on the HRO. The receiver was placed in a cardboard container and shipped to San Francisco via Hong Kong, Kobe, Yokohama and Hawaiian ports — for another 10,000 miles. . . . This was two years ago. . . .

"Now we come to the point. This same unit has been in continuous service here at W6QL and I mean in daily use, since its return from the Orient. Not one single component part including the tube complement, has been replaced, altered, or in any way serviced. I truly believe that this is outstanding service and a record of which any manufacturer can be justly proud. As to the present condition of the HRO may I refer to my log which shows 108 contacts with 79 different South African stations during a six month period in 1939. These were all two-way contacts and many more were heard which were not worked. Of the few remaining 'hard to get' stations not silenced by world conditions, I contend that they still do come through as they did when the HRO was new."

(Signed) J. R. WELLS, W6QL-Ex KA1QL



NATIONAL COMPANY, INC.

MALDEN, MASS.

Amateur TELEVISION Marches On!



W9KNU Goes on the Air with Outstanding Success

Almost before the ink was dry on the final QST article on practical television for the amateur, came word from Robert Thompson (W9KNU) that he had essentially duplicated the RCA system and had transmitted pictures successfully over a distance of about a mile. Arrangements are now being made for further tests between the W9KNU shack in Mt. Carmel, Illinois and Princeton, Indiana, an airline distance of almost nine miles!

Saved for a few modifications dictated by available components, personal preferences and "studio" considerations, Mr. Thompson's transmitting equipment follows closely the experimental outfit made by RCA engineers* to illustrate the possibilities of the

new RCA-1847 Iconoscope in Amateur Television. The receiver used was constructed from a commercially available kit with the r-f section revamped for the 112 Mc band and the sweep circuits altered to accommodate the 30-frame, 120 line picture. A high tripod was made at what Mr. Thompson claims was an "all time low cash outlay of 5c." A suitable lens was made with two magnifying glasses, retailing for \$1.25 each. Throughout the entire equipment, costs were modest, construction not too difficult and results of a type to give a new thrill to the radio pioneer who is looking for something new and different.

Congratulations, W9KNU!

RCA-1847 Amateur Iconoscope

Meet "Mini-ike" . . . The "heart" of the Amateur Television transmitter . . . and made available for amateur and experimental use at an unheard of low price for a tube of its quality and capabilities. 7 7/8" long with a 2" face on which images are focussed for televising.
RCA-1847 Amateur net \$24.50

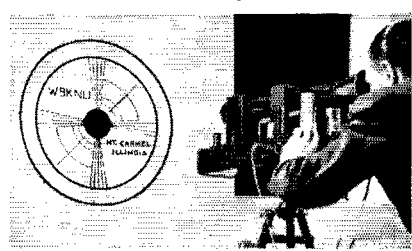

Mr. Thompson finds the bold black and white pattern shown here an aid to focussing. Containing his call letters and address, this pattern can also serve for CQ's.

*See the three construction articles in QST for May, June and July 1940. Reprint booklet including data on the 1847 Iconoscope may be obtained from RCA Power Tube distributors or Commercial Engineering Section, RCA Manufacturing Co., Inc., Harrison, N. J.



Transmitting Tubes

PROVED IN RADIO'S MOST EXACTING APPLICATIONS

RCA MANUFACTURING CO., INC., CAMDEN, N. J. • A Service of The Radio Corporation of America